

TEMP880

- Color type



TEMP850

- Mono type



INSTRUCTION MANUAL

TEMPERATURE
PROGRAMMABLE CONTROLLER

Contents

1 Installation Manual	
1.1 Introductions	1
1.2 Package checklist	3
1.3 Installation	5
1.4 Wiring	9
2 User Manual	
2.1 Setup Button	18
2.2 Input Setting Value	20
2.3 Block diagram of the basic processing	21
2.4 Initial Screen	22
2.5 Main Screen	23
2.6 Operation Screen	24
2.6.1 Program Stop Screen	24
2.6.2 Program Run Screen	27
2.6.3 Fix Stop Screen	29
2.6.4 Fix Run Screen	31
2.7 Operation Setting Screen	33
2.8 Reserve Setting Screen	36
2.9 Graph Setting Screen	37
2.10 Pattern Setting Screen	39
2.10.1 Edit Pattern Screen	40
2.10.2 Repeat Setting Screen	45
2.10.3 Edit File Screen	48
2.10.4 Time Signal Setting Screen	49
2.10.5 Wait Operation Setting Screen	51
2.10.6 Pattern Name Setting Screen	53
2.11 Display Setting Screen	54
2.12 System Setting Screen	55
2.12.1 Input and Input Compensation Setting Screen	56
2.12.2 Control Output and Transmission Setting Screen	61
2.12.3 Inner Signal Setting Screen	66
2.12.4 PID Setting Screen	68
2.12.5 DO CONFIG Setting Screen	73
2.12.6 Alarm and DI Error Name Setting Screen	76
2.12.7 Communication Setting Screen	80
2.12.8 Initial Display and Status Display Lamp Setting Screen	81
2.13 Password Input Screen	83
▪ Simple Example	84
3 Parameter Setting Table	86
4 Communication Manual	
4.1 Communication Specification	94
4.2 Communication Terminal Arrangement	95
4.3 Communication Command	96
4.4 D-Register Explanation	104
▪ D-REGISTER Table	112

※ This is a manual for TEMP880 and TEMP850, transcribed as TEMP880.

1. Installation Manual

1.1 Instructions

Thank you for purchasing Program Indicating Controller TEMP880.
This instruction manual explains how to install and use the product.



Safety Symbol Mark

(A) Represents “Handle with care” or “Caution.” It may cause death, serious injuries, or damages on the machine if it is violated



- (1) Product : It represents the matters for the protection of the user and product.
(2) User’s manual : In order to prevent the user from receiving electric shocks, it describes the matters that demand special attention.

(B) Represents “Terminal”



Please make sure the product is earthed when installing and using.

(C) Represents “Additional explanation”



Describes supplementary explanation.

(D) Represents “Reference”



Describes referential explanation and reference page.



Caution for the manual

- (A) Make sure the final users keep this manual, and place it at which it can be easily found.
(B) Use the product after having through full knowledge of the manual.
(C) This manual describes function of the product specifically, and does not warrant matters that are not included in the manual.
(D) The user should not edit or photo copy any part of the manual without notice.
(E) Some matters on the manual may be changed without notice.
(F) If any errors are found on the manual, please contact where it was purchased or the business department.



Caution for the product safety and remodeling

- (A) For the protection and safety of the product and system connected to it, use the product after having through full knowledge of the manual.
- (B) The company is not liable for any damages caused by actions that are inconsistent with the manual's instruction or carelessness.
- (C) For the protection and safety of the product and system connected to it, install additional protection or safety circuit on the outside of the product. Interior remodeling or any changes are forbidden.
- (D) Do not disassemble or remodel. It causes electric shocks, fire, or malfunctioning.
- (E) When changing the product parts or supplies, contact our company's business department.
- (F) Inflow of moisture may cause malfunctioning.
- (G) A deep impact on the product may cause damages and malfunctioning of the product.



Exemption from responsibility

- (A) The company is not liable for any warranty or obligations that are not specified in quality guarantee qualification of the company.
- (B) The company is not liable for any direct or indirect harm of the user or third person, which are caused by unexpected defect or natural disaster.



Quality guarantee qualification

- (A) The product is under warranty for one year from purchase. For damages occurred under normal circumstances as stated in the manual, the product will be repaired without cost.
- (B) For damages occurred when the warranty is invalid, it will be repaired under the company standard at cost.
- (C) For the following circumstances, repair is offered at cost even if damages occurred during warrant period.
 - (1) Breakdown from user's mistake or fault (Ex: Initialization due to loss of password)
 - (2) Breakdown from a natural disaster (Ex : fire, flood, and etc.)
 - (3) Breakdown from moving after install
 - (4) Breakdown from disassembling, remodeling or damaging
 - (5) Breakdown from power supply such as unstable electricity
 - (6) And others.
- (F) Contact the company's business department if any repair is needed.

1.2 Package checklist

- ▶ Check the exterior of the product to make sure the product is not damaged when it is first purchased. Also, check the following matters.

1.2.1 Features of ordered product confirmation

- ▶ Confirm the obtained product is identical with what you order.
How to confirm : Confirm feature code of label on the right side of the box or left side of the product case.

Type	Feature Code	Appendix Code	UDC	Contents
TEMP880	- 1			I/O1 BOARD (10 POINT : basis) →24V SMPS internally equipped
	- 2			I/O2 BOARD (10 POINT : addition)
		0		RS232C (basis)
		1		RS485 (option)
				/UDC

☞ In the case of generic model, the code is TEMP880-10 (I/O 10POINT + RS232C)

1.2.2 Contents confirmation

- ▶ Confirm the following contents are included.

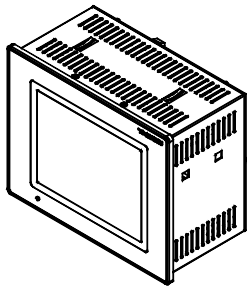
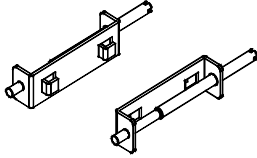
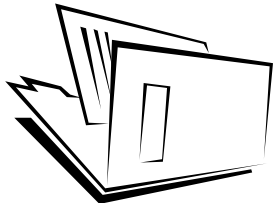
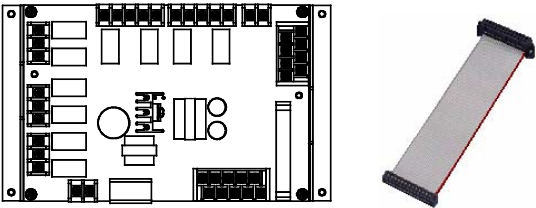
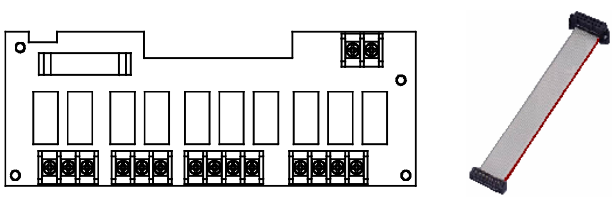
TEMP880 mainframe	Fixed mount	Manual
		
I/O1 BOARD + 30 Pin Cable → 24V SMPS included(RELAY operation)	I/O2 BOARD + 14 Pin Cable → included only for TEMP880-20 or 21	
		

1.2.3 Processing of damaged product

- ▶ Contact where the products is purchased or the company's business department if you find any missing or damaged parts.



Lifetime of the parts in the controller

- ▶ Check replacement period for the following non-durable parts and replace them before the period exceeds.

■ FUSE	SR-5:630mA/250VAC equivalent product	: semi-permanent
■ BACKLIGHT		: 10,000 ~ 15,000 HOUR
■ RELAY	JQ1P-DC24V equivalent product	: less than ON/OFF 300,000
■ BATTERY	ER3VT(3.6V) 1/2AA equivalent product	: less than 200,000 HOUR

- ☞ For batteries, use the identical product or the ones with same capacity to prevent explosion. Also, separate used batteries from other garbage when you dispose them.

1.3 INSTALLATION

1.3.1 INSTALLATION PLACE AND ENVIRONMENT



Caution for installation place and environment

- (A) To prevent from getting electric shocks, turn on the product after it is installed on the panel.
- (B) Do not install the product under the following environment.
 - Place where people can touch the ground connection without noticing.
 - Place exposed directly to machinery vibration or shock.
 - Place exposed to corrosion or combustion gas.
 - Place where temperature fluctuates intensely.
 - Place where temperature is extremely high(over 50℃) or low (below 10℃)
 - Place exposed to the direct sun ray.
 - Place affected a lot by an electric wave.
 - Humid place (humidity is over 85%)
 - Place where keeps inflammable things.
 - Place where contains a lot of dust or salt.
 - Place affected a lot by an ultraviolet ray.

- ☞ Even though the product case is SPCC-SD and BEZEL is made of ABS/PC noninflammable material, do not install the product around inflammable things. Especially, do not place the product on an inflammable material.

1.3.2 CAUTION FOR INSTALLATION



Caution for installation

- (A) Do not place machines or wires that cause noise.
- (B) Keep the product within 10~50℃, 20~90%RH(dew free). Especially, keep it away from things that generate heat extremely.
- (C) Do not install the product on a slant..
- (D) Keep the product within-25~70℃, 5~95%RH(dew free). When operating it below 10℃, warm it up enough before use it.
- (E) When wiring, turn off all power source.
- (F) This product operates at 100~240VAC, 50/60Hz 15VAmax. Using power out of this range may cause fire or electric shocks.
- (G) Do not operate with wet hands. There is danger of an electric shock.
- (H) Follow instructions to prevent fire, electric shocks, and damage.
- (I) Install and use the product as the manual instructs.
- (J) For ground connection, follow the manual. However, never earth on water pipe, gas pipe, phone cable, or lightening rod. There is danger of explosion and fire..
- (K) Do not turn on the product before the parts are connected to each other. It causes damage and breakdown.
- (L) Do not block the radiator of the product. Blocking the radiator causes breakdown.
- (M) Do not install I/O Relay Board on a slant. Install it inside of a thermo humidistat. Use it by fixing after tightly cramping it with a bolt and nut on a hole for fixation that is open on the board.
- (N) Over voltage protection is Category II, and environment for usage is Degree II.

1.3.3 EXTERIOR SIZE

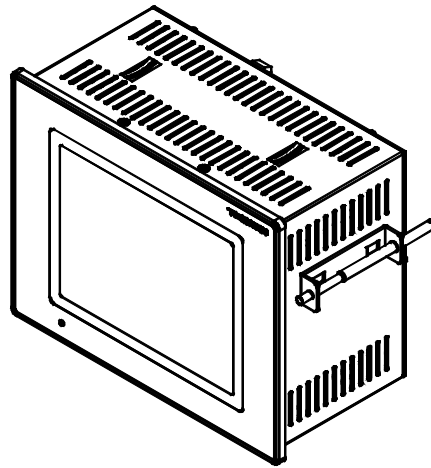
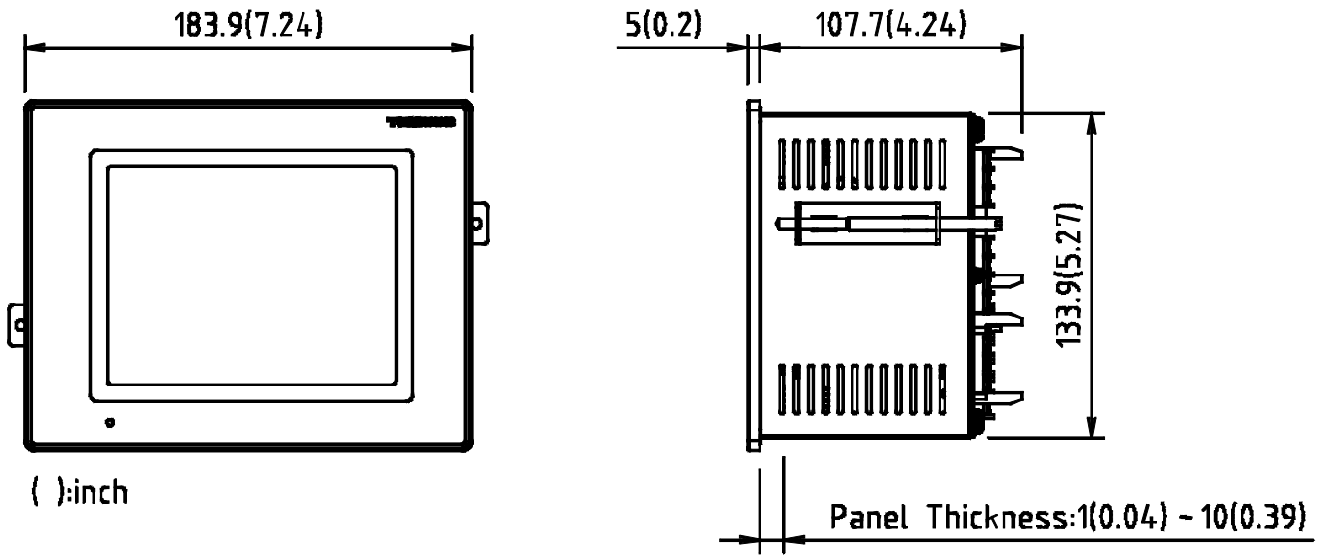

1.3.4 PANEL CUTTING SIZE

① General Adhesion

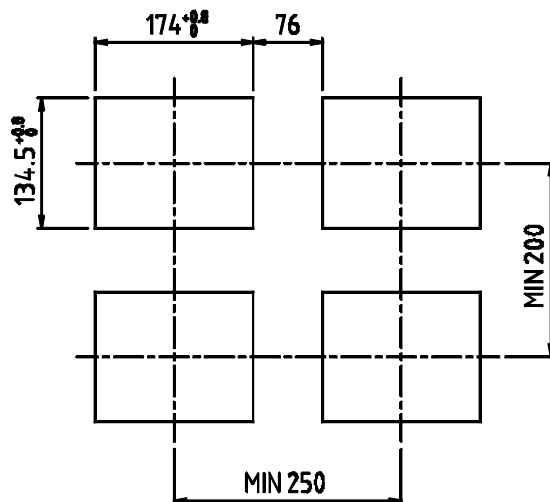

② Close Adhesion

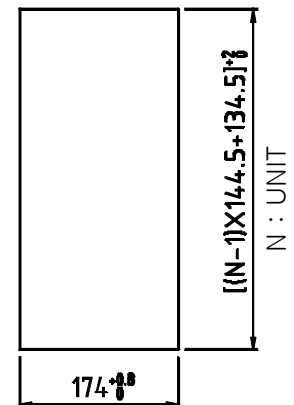

1.3.5 HOW TO ADHERE MOUNT

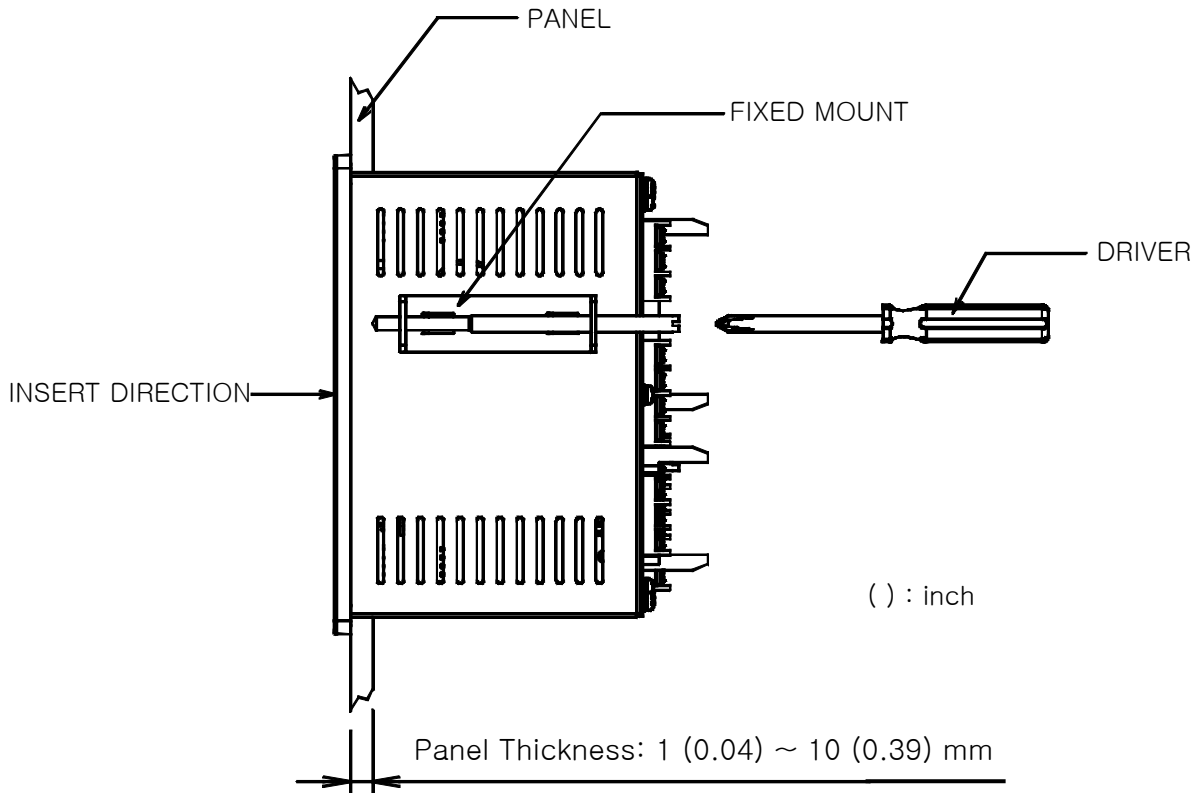

- ① Cut panel that you wish to set up. (1.3.4. Refer PANEL CUTTING SIZE)
- ② Insert the product from the back side into the installing hole as figure above.
- ③ Fix the mainframe using fixed mount located on left and right side of the mainframe.

**NOTE****CAUTION(Mount)**

- ▶ When you fix the fixed mount, do not tighten it intensely.

1.3.6 CUTOFF CIRCUIT INSTALLATION

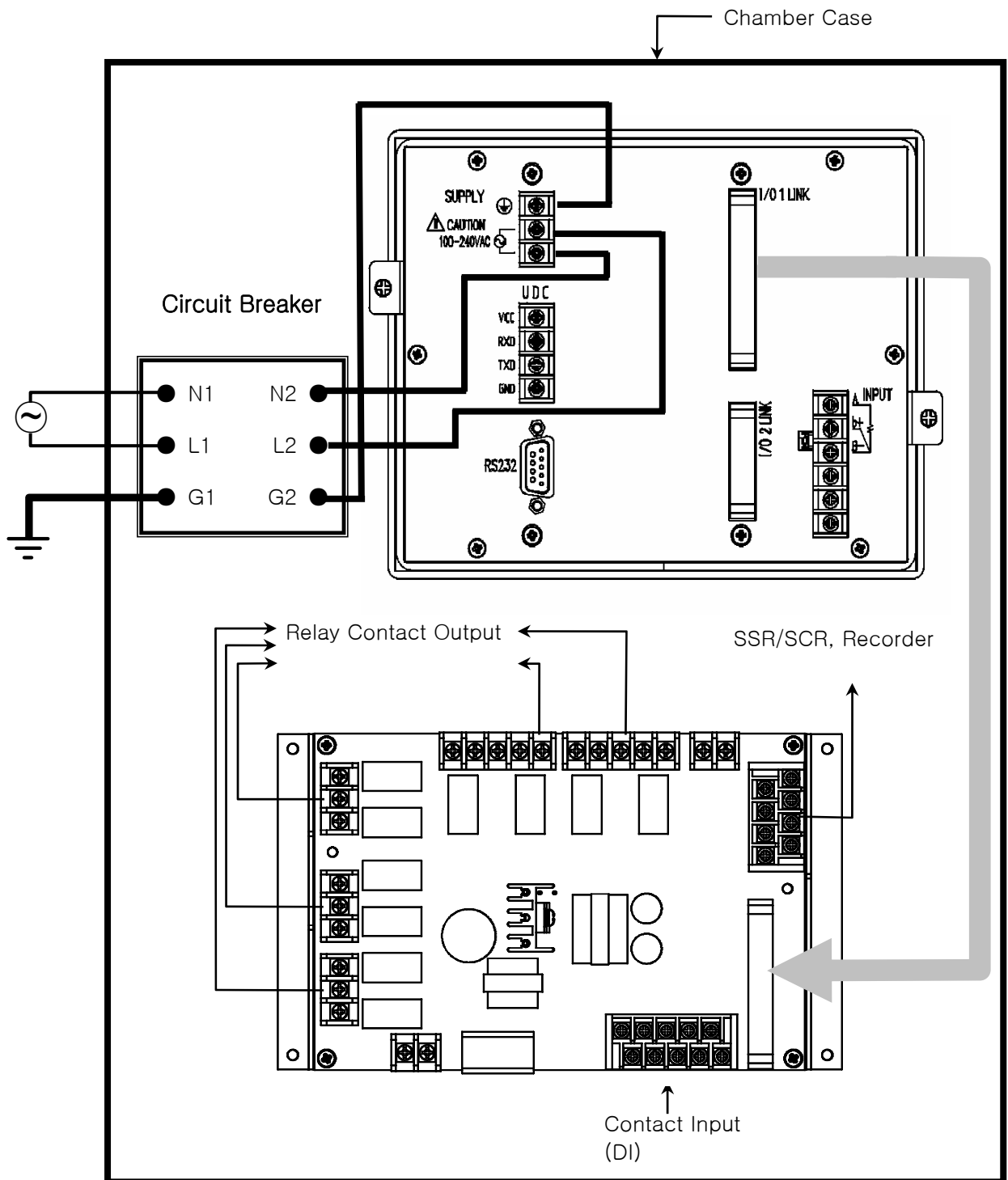

Ground Connection

- ▶ You must earth on the electric wiring of the power source part.
- ▶ Power source should be supplied to the inner part of TEMP880 through the power cutoff.
- ▶ Use the power cutoff after it is earthed evenly.

1.4 WIRING



Caution

- ▶ Using a tester, make sure all power sources are turned off and wiring cable is not active.
- ▶ Do not touch the terminal when the wire is active due to potential electric shocks.
- ▶ Wire after the main power source is turned off.

1.4.1 HOW TO WIRE

1.4.1.1 Recommended Power Cable Feature

- ▶ Vinyl Insulated Wire KSC 3304 0.9~2.0 mm²

1.4.1.2 Recommended Terminal Feature

- ▶ Use compression terminal, which is suitable for M3.5 SCREW and adhered to insulated sleeve as the figure below.

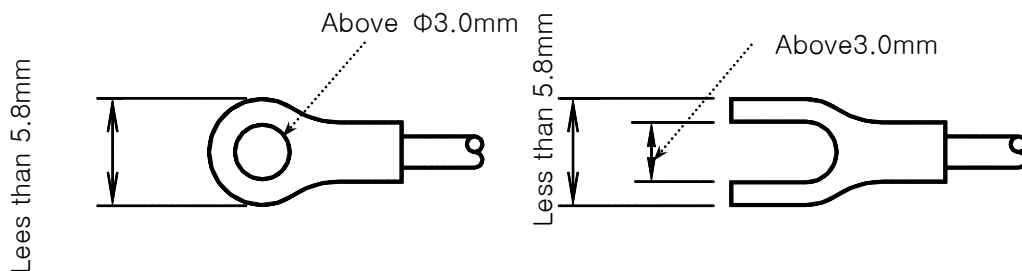

1.4.1.3 Solution for Noise

■ Cause of noise

- (A) Relay and contact
- (B) Solenoid Coil, Solenoid Valve
- (C) Power source line
- (D) Induced load
- (E) Inverter
- (F) Commutator of motor
- (G) Phase angle control SCR
- (H) Wireless communicator
- (I) Welding machine
- (J) High voltage lighter

■ Solution for noise

Pay attention to the following matters to avoid the source of noise when you wire.

- (A) Wire input circuit with space from the power and ground connection circuit.
- (B) Use shield wire for noise from power cut induction.
Please connect shield wire to a grounding connection terminal according to needs while avoiding 2 type grounding.
- (C) Please lay wires after twisting the input wire with a narrow interval according to electronic inducement.
- (D) Refer to the use of 1.4.2.9 supplementary RELAY as you need.

1.4.2 TERMINAL WIRING DIAGRAM

1.4.2.1 TEMP880 Mainframe Terminal

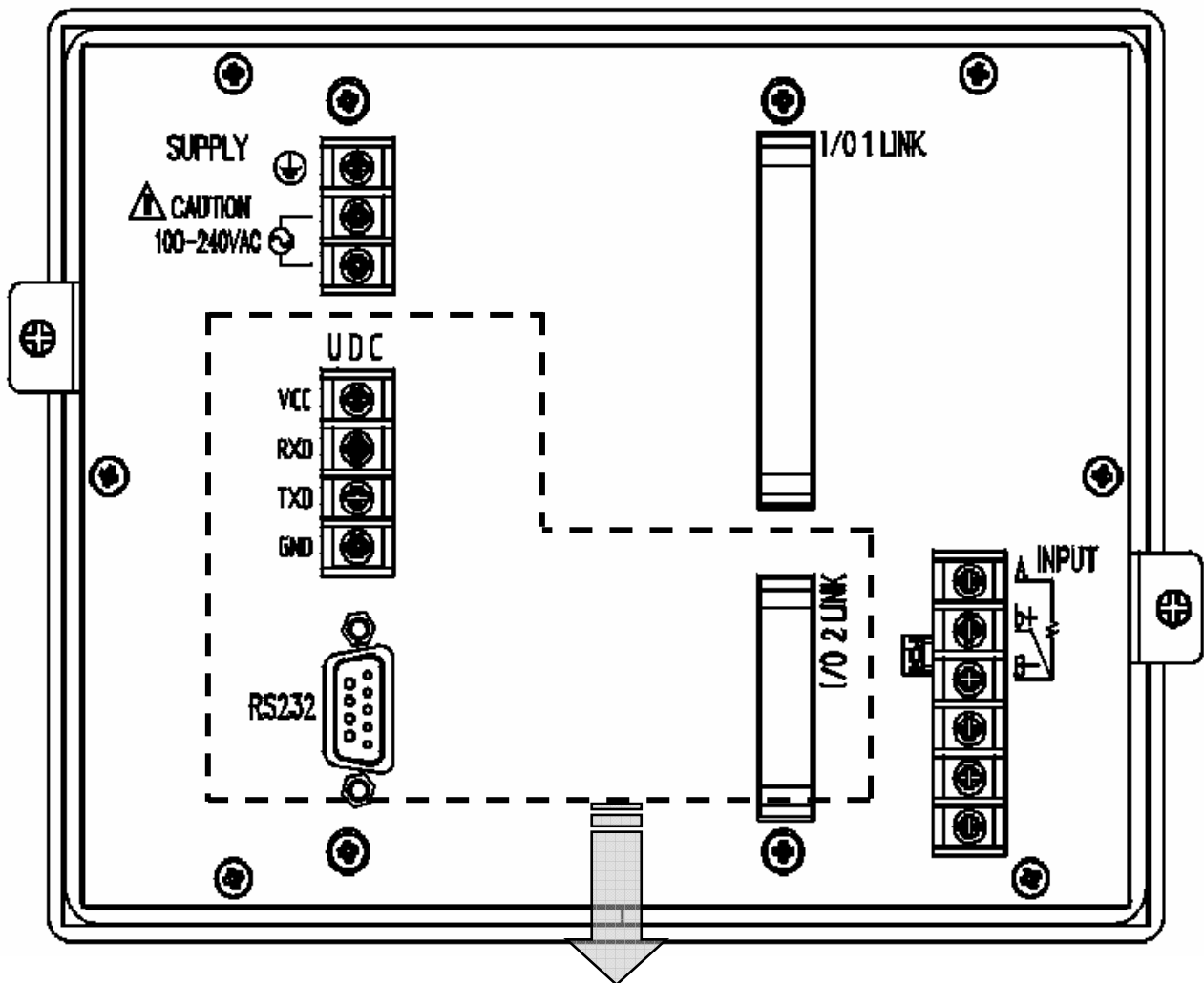

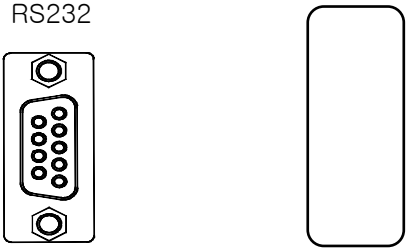
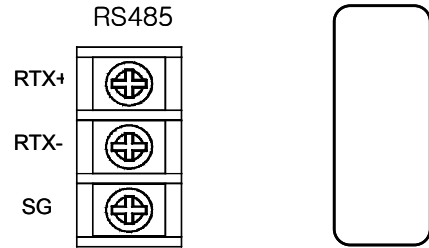
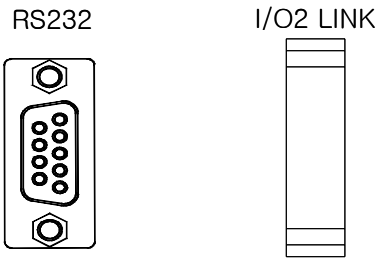
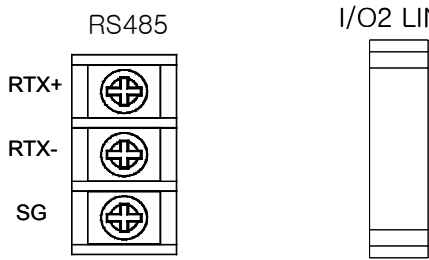
STANDARD : TEMP880-10(RS232C + I/O1)	OPTION1 : TEMP880-11(RS485 + I/O1)
	
Add UDC Option : TEMP880-10/UDC	Add UDC Option: TEMP880-11/UDC
OPTION2 : TEMP880-20(RS232C + I/O1 + I/O2)	OPTION3 : TEMP880-21(RS485 + I/O1 + I/O2)
	
Add UDC Option : TEMP880-20/UDC	Add UDC Option : TEMP880-21/UDC

1.4.2.2 I/O1 RELAY BOARD Terminal

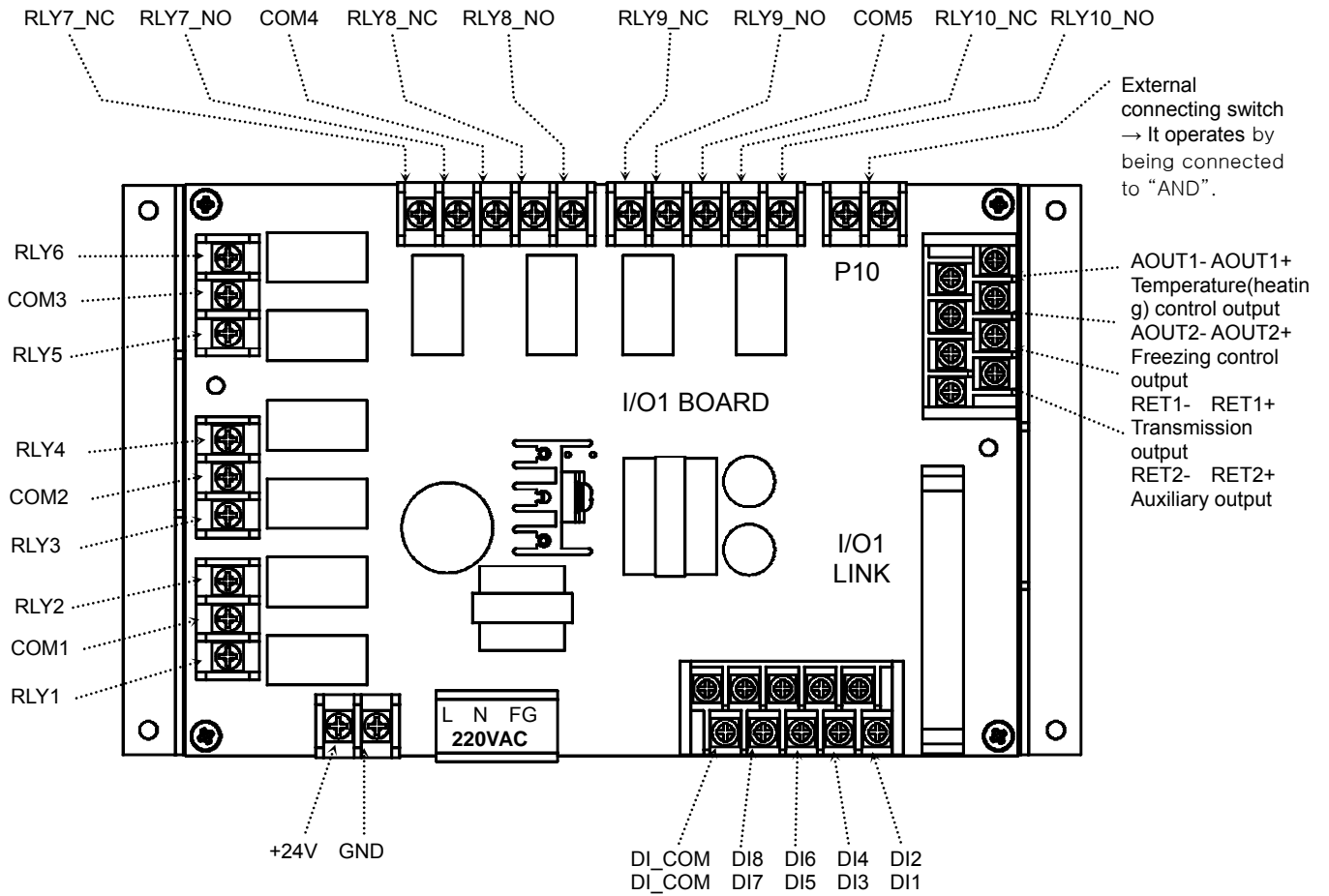

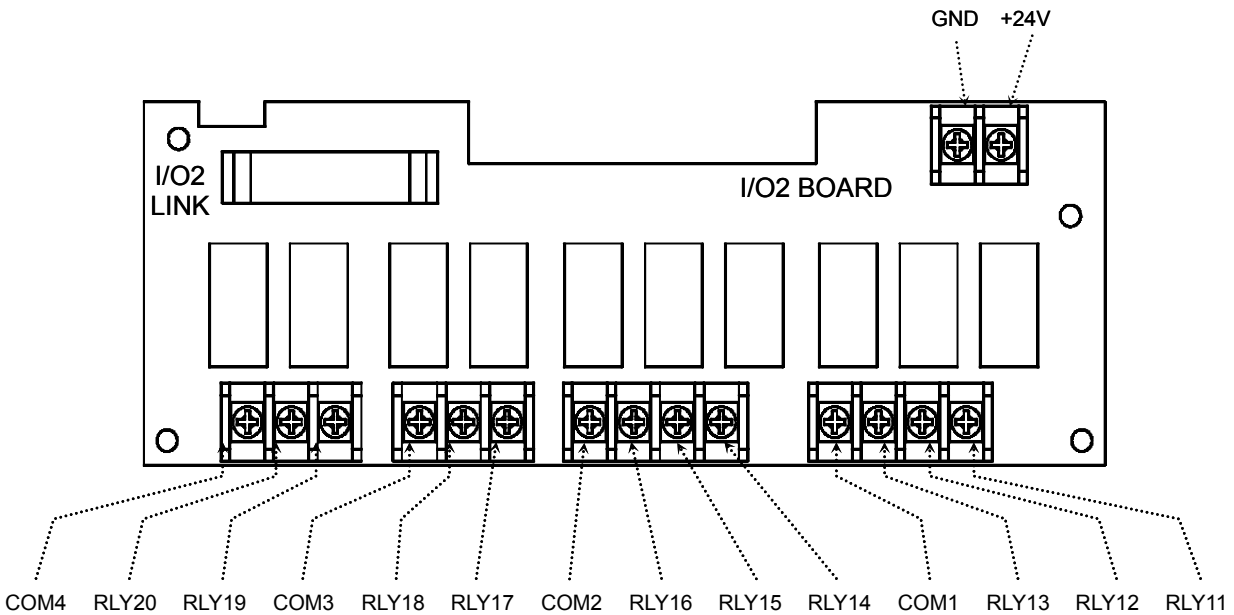

1.4.2.3 I/O2 RELAY BOARD TERMINAL

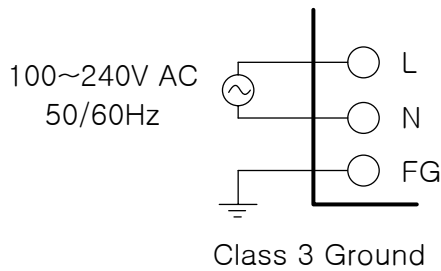

1.4.2.4 Wiring Ground Connection and Power Source

- ▶ Wire ground connection with cable thicker than 2 mm² and ground connection resistance below 100Ω. Also, ground connection cable should be wired within 20m.
- ▶ Earth 1 point from ground connection terminal, and do not wire passing ground connection terminal.
- ▶ Use vinyl insulation wire(KSC 3304) or cable that has similar capacity for the power source wiring.





CAUTION You must earth FRAME GROUND(FG).

1.4.2.5 Wiring Analog Input



CAUTION

- ▶ Turn off the mainframe of TEMP880 and external power source due to potential electric shocks.
- ▶ Use input wire that is adhere to shield. Also, shield should be done as 1point ground connection.
- ▶ Wire measuring input signal line leaving a space from the power circuit or ground connection circuit.
- ▶ Use wire that has little conduct resistance and doesn't have resistance difference among three wires.

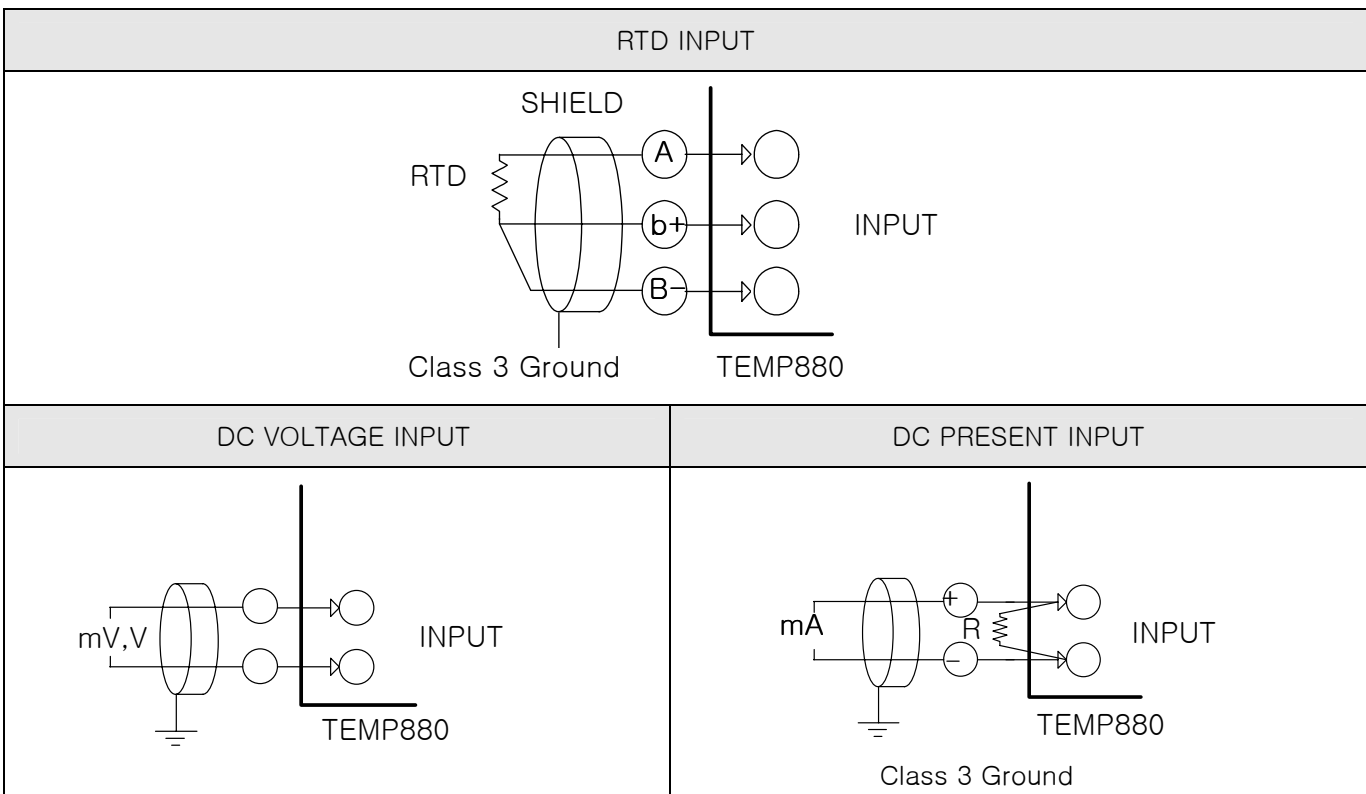

1.4.2.6 Control Output (Voltage pulse Output, Electric Present Output) and Wiring Transmission Output

CAUTION  **Caution**

- ▶ Turn off TEMP880 mainframe power and external power supply when wiring the control output (SSR, SCR) and transmission output due to danger of electric shocks.
- ▶ Be careful with output polarity. Incorrect connection causes damage to the mainframe.
- ▶ Use output wire that has shield attached. Shield should be done as 1point ground connection.

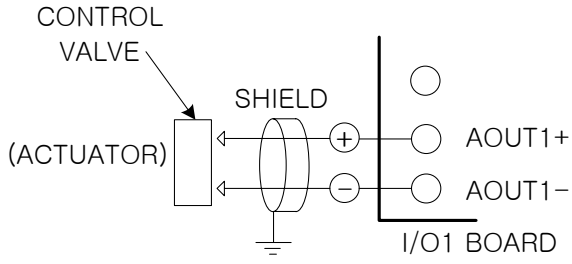
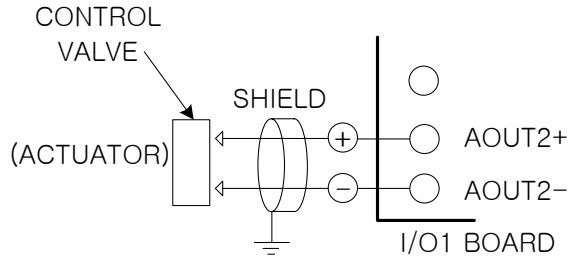
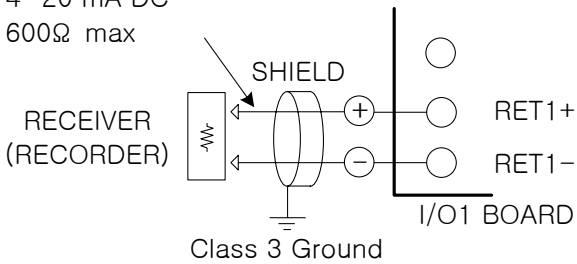
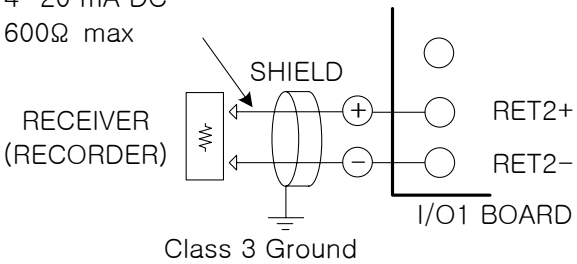
Temperature(heating) Control Output Wire (SSR/4~20mA)	Cooling Control Output Wire (SSR/4~20mA)
 <p>Class 3 Ground SSR : 12V DC min, 600Ω min SCR : 4~20mA DC min, 600Ω max</p>	 <p>Class 3 Ground SSR : 12V DC min, 600Ω min SCR : 4~20mA DC min, 600Ω max</p>
Transmission Output Wire (4~20mA)	Auxiliary Output Wire (4~20mA)
<p>4~20 mA DC 600Ω max</p>  <p>Class 3 Ground</p>	<p>4~20 mA DC 600Ω max</p>  <p>Class 3 Ground</p>

1.4.2.7 External Contact Point Output (RELAY) Wire

 **Caution** ▶ Turn off TEMP880 mainframe power and external power supply when wiring the external contact point output due to danger of electric shocks.

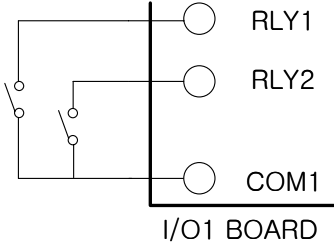
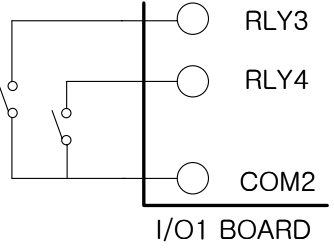
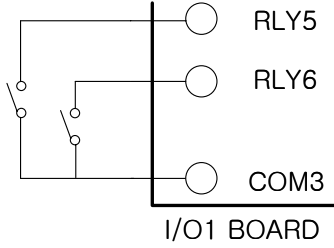
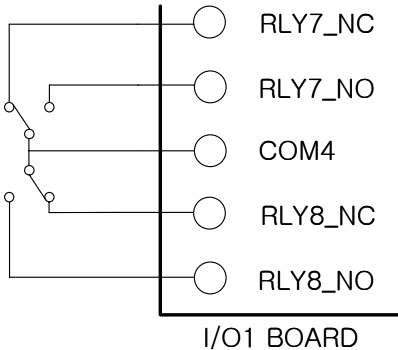
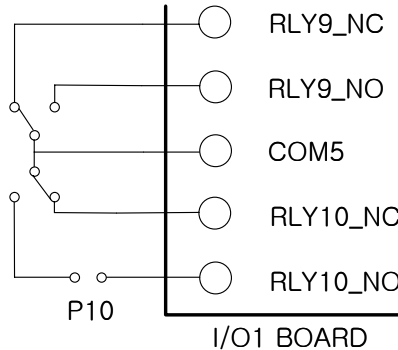
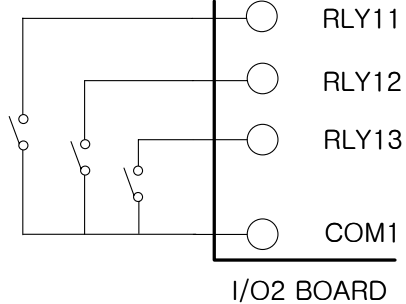
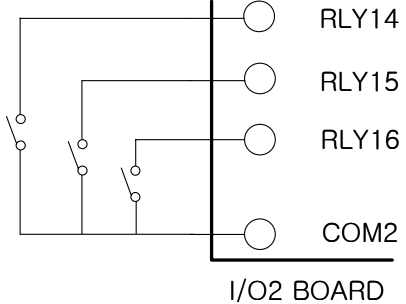
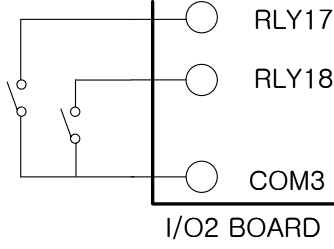
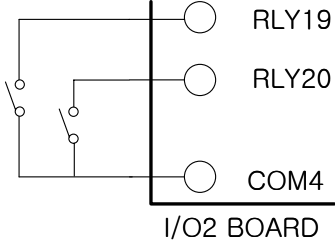
Below 30V DC 5A, below 250V AC 5A	Below 30V DC 5A, below 250V AC 5A	Below 30V DC 5A, below 250V AC 5A
 <p>I/O1 BOARD</p>	 <p>I/O1 BOARD</p>	 <p>I/O1 BOARD</p>
Below NO(Normal Open):30V DC 5A, below 250V AC 5A Below NC(Normal Close):30V DC 1A, below 250V AC 2A	Below NO(Normal Open):30V DC 5A, below 250V AC 5A Below NC(Normal Close):30V DC 1A, below 250V AC 2A	
 <p>I/O1 BOARD</p>	 <p>I/O1 BOARD</p>	
Below 30V DC 5A, below 250V AC 5A	Below 30V DC 5A, below 250V AC 5A	
 <p>I/O2 BOARD</p>	 <p>I/O2 BOARD</p>	
Below 30V DC 5A, below 250V AC 5A	Below 30V DC 5A, below 250V AC 5A	
 <p>I/O2 BOARD</p>	 <p>I/O2 BOARD</p>	

1.4.2.8 External contract point (DI) wiring

	<p>Caution</p> <p>▶ Turn off TEMP880 mainframe power and external power supply when wiring the external contact point input due to danger of electric shocks.</p>
---	--

- ▶ Use voltage free contact point (relay contact point) for external contact point.
- ▶ For turned of terminal voltage (about 5V) and turned on present (about 1mA), use voltage free contact point that has enough switch ability.
- ▶ Use open collector which has under 2V and 100μA present when turned on.

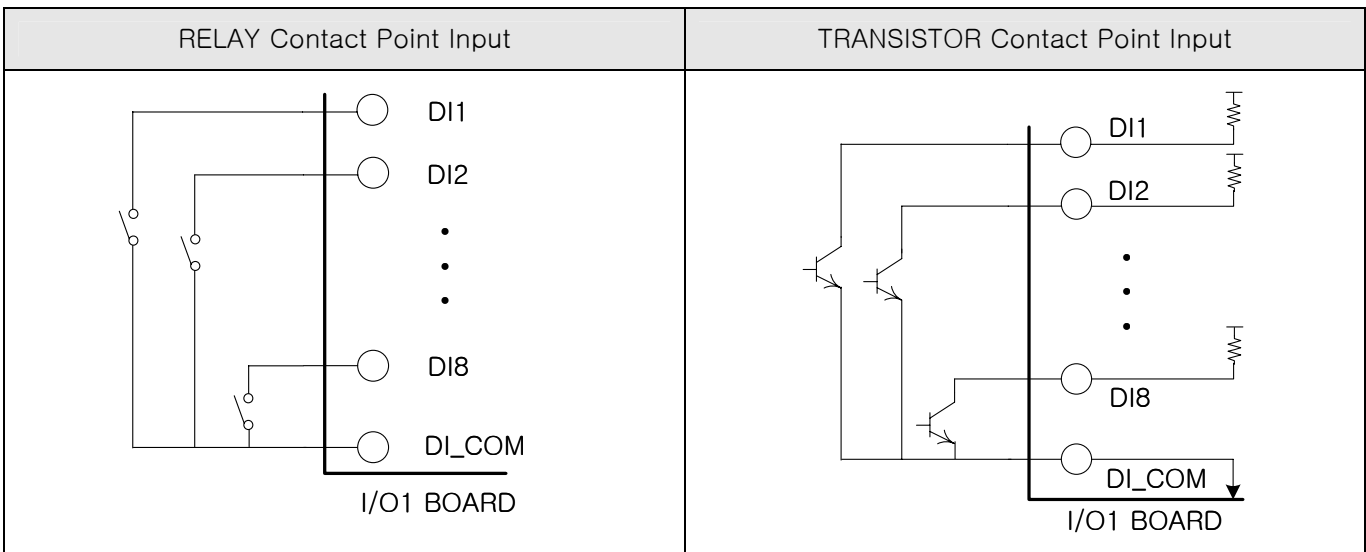

1.4.2.9 Use of Supporting Relay

Caution

CAUTION ▶ When resistance load exceeds relay feature of the product, use supporting relay to turn on/off load.

- ▶ When using inductance load as supporting relay or solenoid valve, use surge suppressor, sparks removal as circuit and insert CR filter (when using AC) or diode(when using DC) parallel to prevent relay breakdown.
- ▶ Recommended CR FILTER
 - Sungho Electronics : BSE104R120 25V (0.1μ+120Ω)
 - HANA PARTS CO. : HN2EAC
 - 松尾電機(株) : CR UNIT 953, 955 etc
 - (株)指月電機製作所 : SKV, SKVB etc
 - 信英通信工業(株) : CR-CFS, CR-U etc

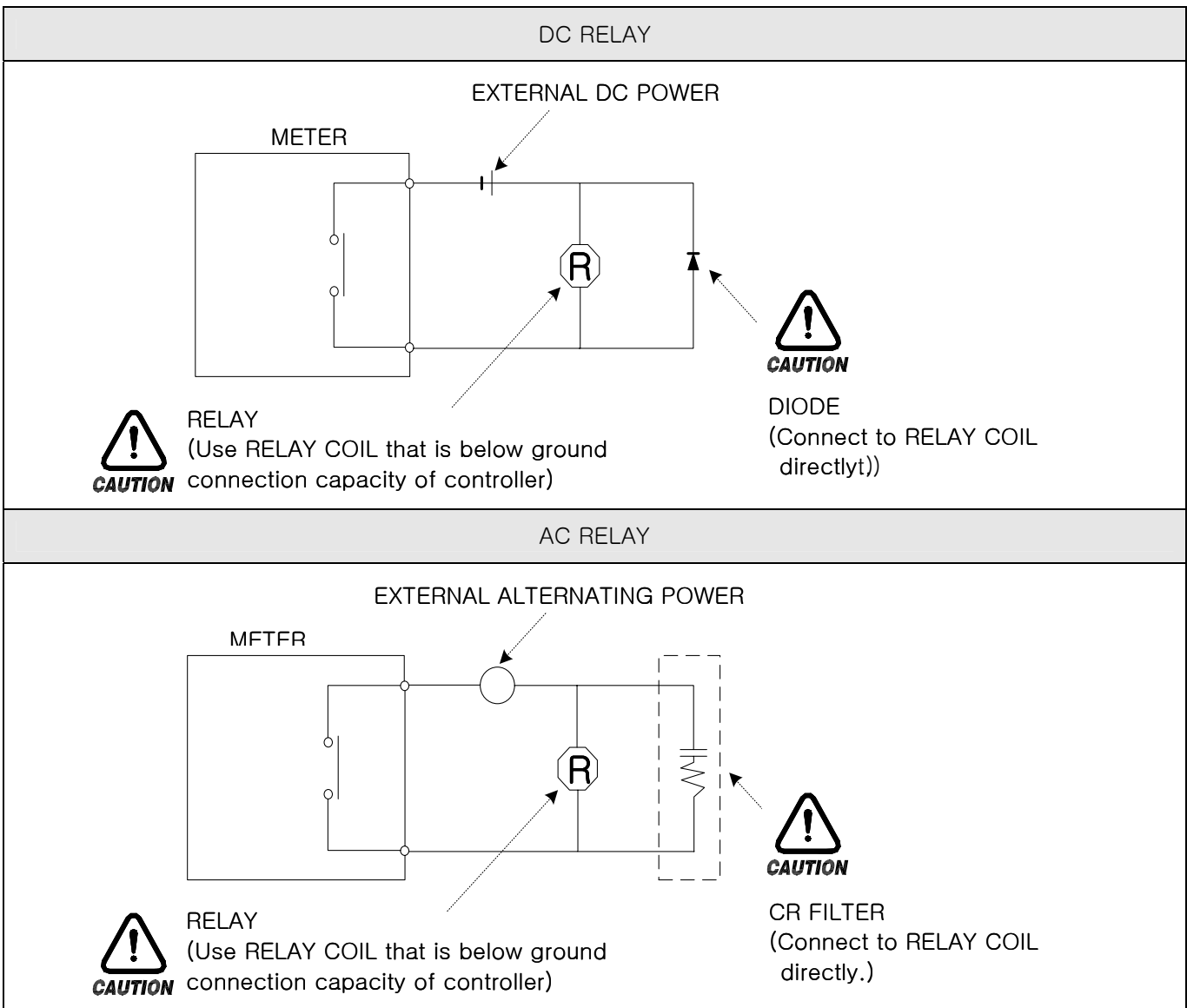

1.4.2.10 Communication (RS485/RS232C) Wiring



Caution

▶ Turn off TEMP880 mainframe power and external power supply when wiring communication due to danger of electric shocks.

1.4.2.10.1 Wiring RS485

- ▶ It is possible for slave (TEMP880) to connect multidrop maximum of 99.
- ▶ For TEMP880 or MASTER (PC, PLC), connect division resistance(200Ω 1/4W) on both sides of communication channel.

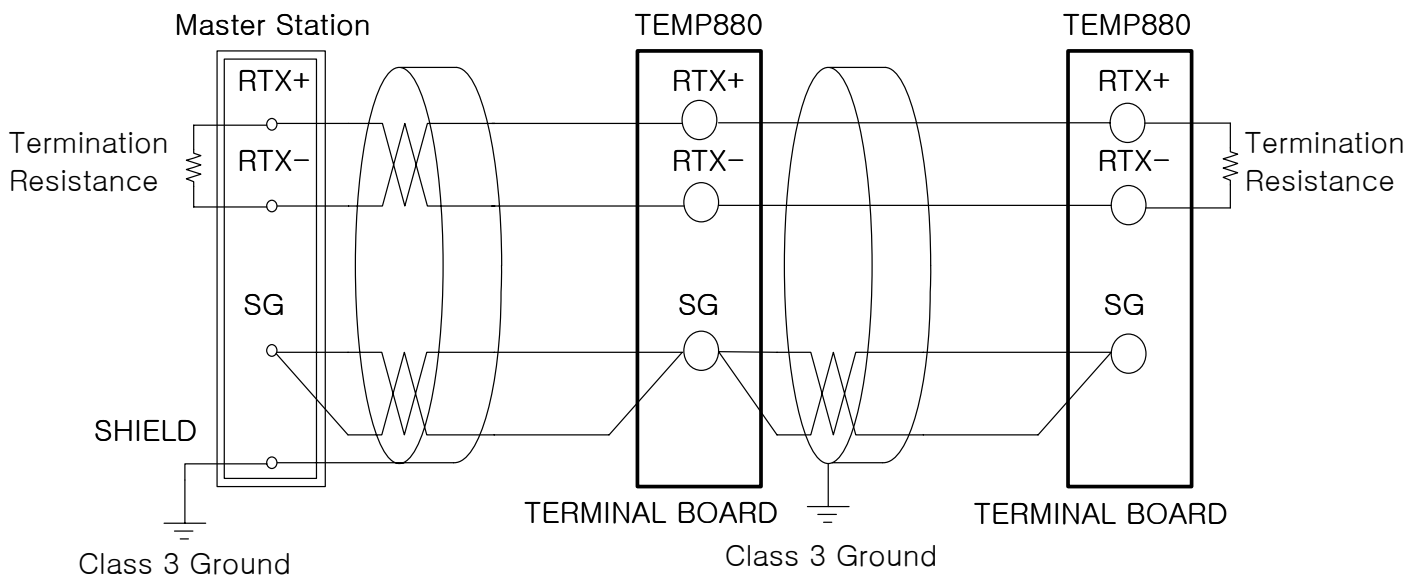

1.4.2.10.2 Wiring RS232C

- ▶ Connector : Wiring with D-Sub 9 PIN

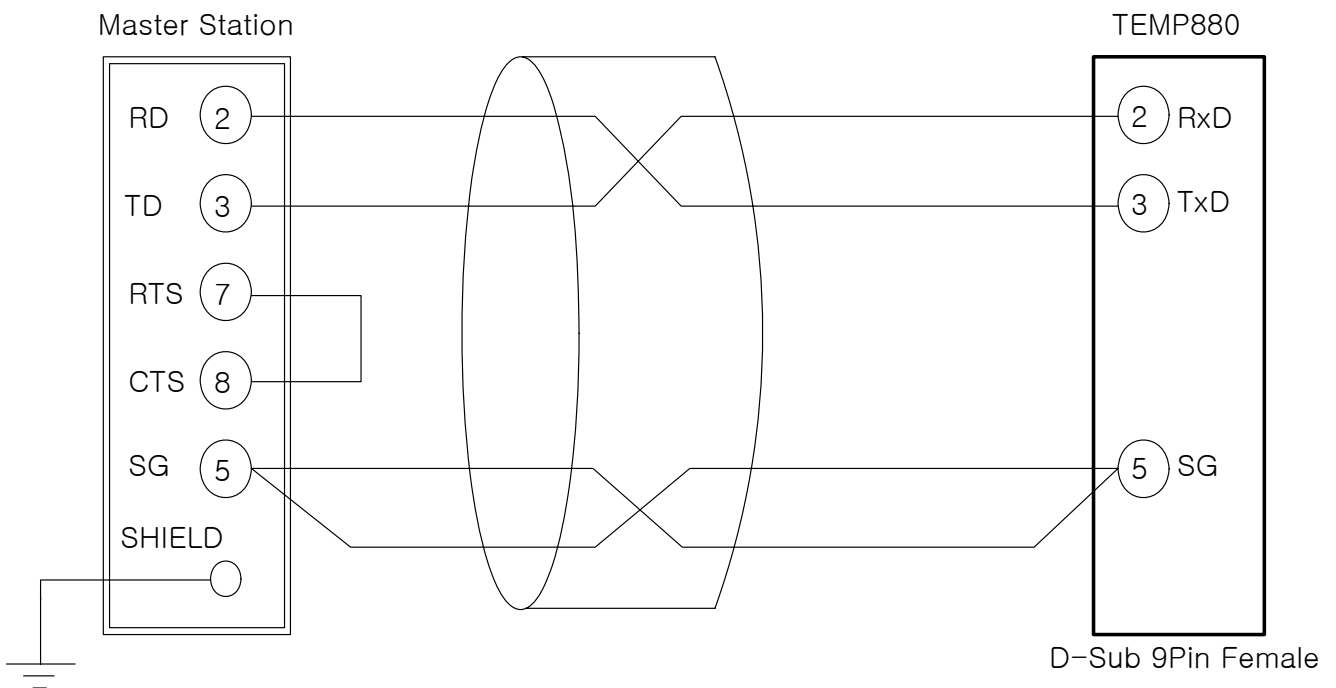

2. USER MANUAL





2.1 SETUP BUTTON

- ▶ This product is a programmable controller that is set up as touch screen for a user to use easily.

2.1.1 BASIC SETUP BUTTON

- ▶ Basic control button is as the following diagram(1-1).

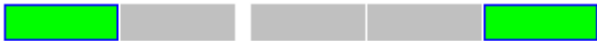
Diagram 1-1. BASIC SETUP BUTTON

	Button Type		Button Explanation
1	Upper Main Bar		Change screen according to left and right touch.
2	General Active Button		For general action or choice.
3	Page Up/Down Button		Used for switching pages in the same screen.
4	Setting Value Choice Button		Used for choosing setting value.
5	Setting Value Input Button		Switch to setting value input screen.
6	Setting Value Change Button		Used for changing more than two setting values.

2.1.2 SETTING VALUE INPUT KEY

- ▶ If you press setting value input button on general setting button as above, setting value input key appears and you can enter data.
- ▶ If you enter data that exceeds input range, error message appears(“-LIMIT ERR”) with beeping sound.

① INPUT KEY ONLY FOR SETTING NUMBERS

01 SEQ TEMP SP [-50.00 - 150.00]							
0	1	2	3	4	+/-	←	ESC
5	6	7	8	9	.	CLR	ENT ↵

② INPUT KEY FOR SETTING DI ERROR NAMES

PT 8 NAME [ALPHA NUMERIC]							
, :- 0	QZ. 1	ABC 2	DEF 3	GHI 4	TOG	←	ESC
JKL 5	MNO 6	PRS 7	TUV 8	WXY 9	SP	CLR	ENT ↵

③ INPUT KEY FOR TIME SIGNAL SETTING

01 SEG TS NO [0 - 7]							
TS1	0	TS2	1	TS3	2	TS4	7
0	1	2	3	4	+/-	←	ESC
5	6	7	8	9	.	CLR	ENT ↵

**NOTE****Touch Key Lock Removal**

- ▶ Since setting value does not get entered when key lock is turned on, enter after turn off key lock..
- ☞ Refer to [2.7 OPERATION SETTING SCREEN](#) for detail.

2.1.3 VALIDITY FOR SETTING BUTTON AND SETTING VALUE

- ▶ The product is made to check validity of entered setting value by making beeping noise.
- ☞ "beep" : when press general setting button and setting value is entered correctly.
- ☞ "beep-bleep" : Data entered by setting value input key exceeds the range.

**CAUTION****Caution**

- ▶ Do not press general setting button and setting value input key with sharp thing or nail. Or, the product can be damaged.

2.2 INPUT SETTING VALUE

- ▶ All input data for the product is set by input key such as setting value input key, test name input key, and time signal input key.
- ▶ Setting value input key(Diagram 1-1) appears when you press input button, and you can enter input value.
- ▶ Refer to 2.10.4 TIME SIGNAL SETTING for time signal input key.
- ▶ Refer to 2.10.6 PATTERN NAME SETTING for test name setting input key.

2.2.1 FUNCTION OF SETTING VALUE INPUT KEY

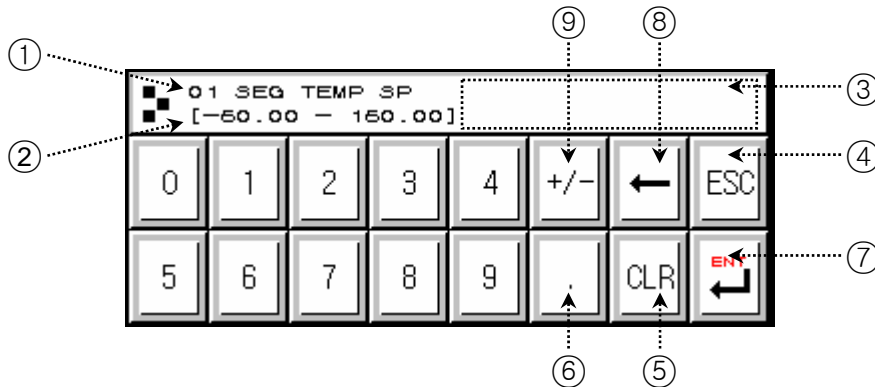

- ① Shows parameter
- ② Shows setting range
- ③ When exceeds setting range, error message (“-LIMIT ERR”) appears.
- ④ Use this button to stop entering data and return to the original screen
- ⑤ When erase all input data.
- ⑥ When enter decimal points..
- ⑦ When save entered data and restore the original screen.
- ⑧ When edit entered data, erase data one by one.
- ⑨ When enter signs(+/-).

2.2.2 HOW TO SET PARAMETER

- ▶ If you wish to setting value from -50.00 to -12.57, take the following steps.
 - Press setting value input button.
 - Press following numbers with such order (①→②→③→④→⑤→⑥), and finally "ENT" key(⑦)

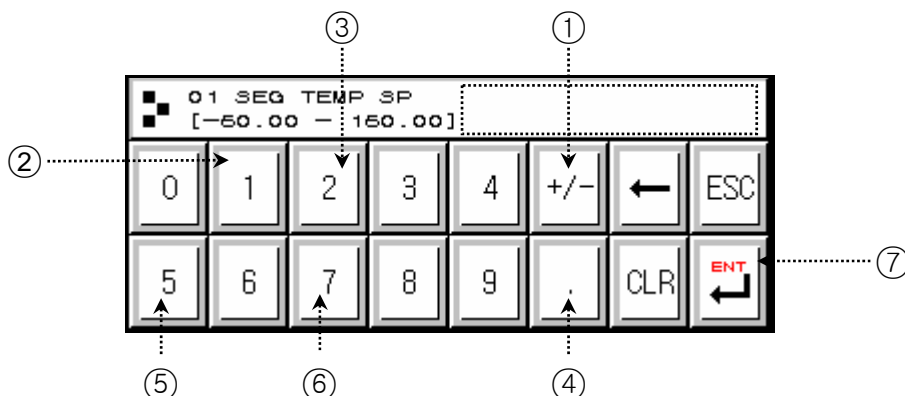

2.3 BLOCK DIAGRAM OF THE BASIC PROCESSING

► The picture below roughly diagrammatize the flow.

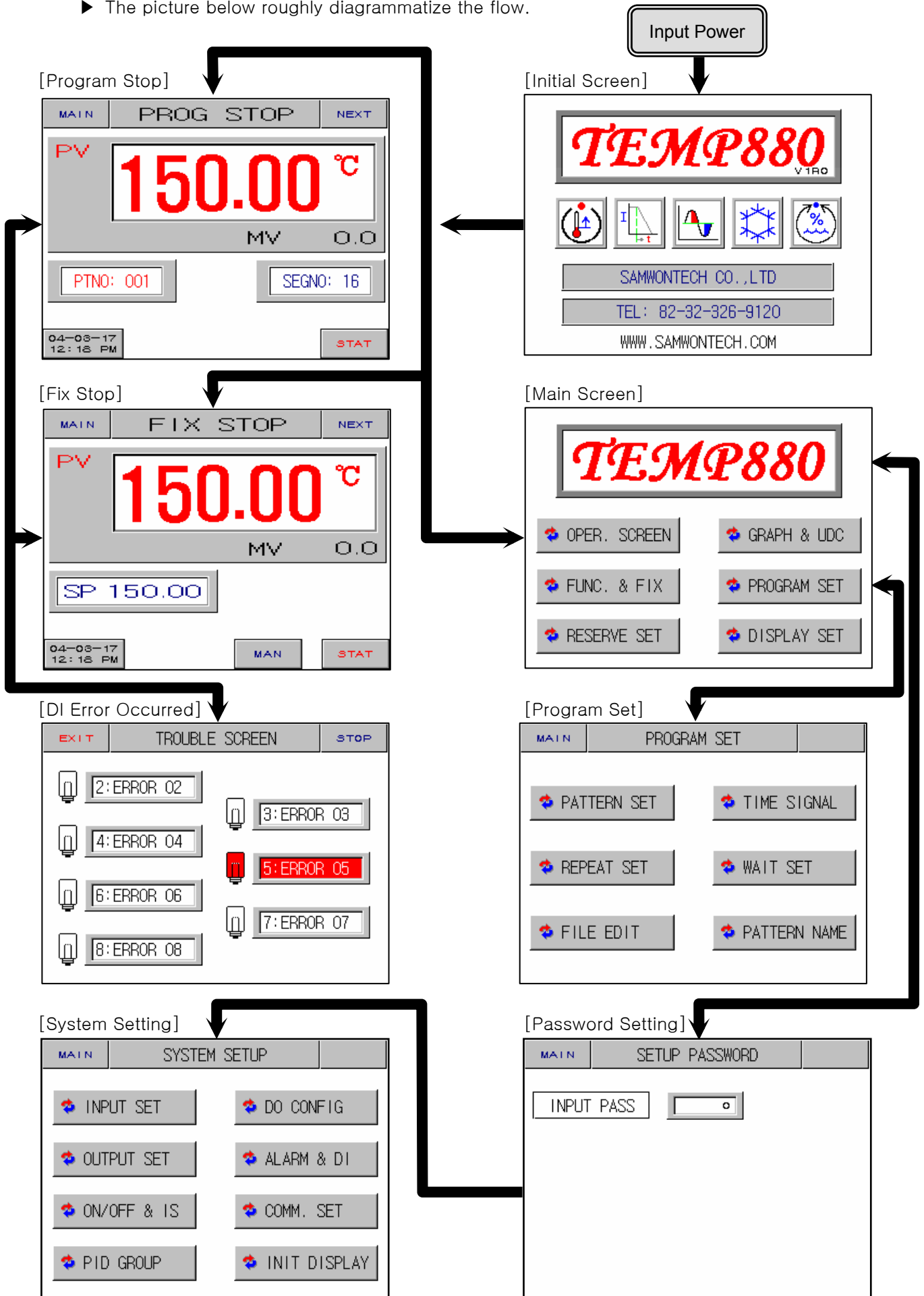

2.4 INITIAL SCREEN

- ▶ Screen that displays when initially input power.
- ▶ It moves to 2.6 OPERATION SCREEN after three seconds automatically.

Figure 2-1. Initial Screen

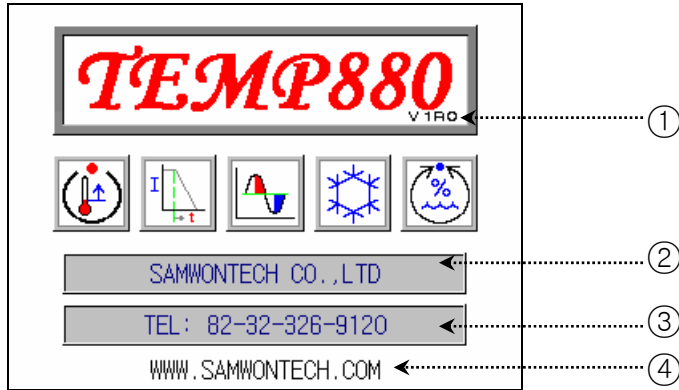

No.	Instruction	Contents	Additional Explanation
①	Version	Indicates version info of the product.	▶ V1R0 → VERSION 1, REVISION 0
②	Company Name	Indicates name of the company.	▶ It may be edited at <u>2.12.8 INITIAL DISPLAY AND STATUS DISPLAY LAMP SETTING.</u>
③	Phone	Indicates contact phone number.	
④	Webpage	Indicates webpage address.	

2.5 MAIN SCREEN

► It is a center of screen movement.

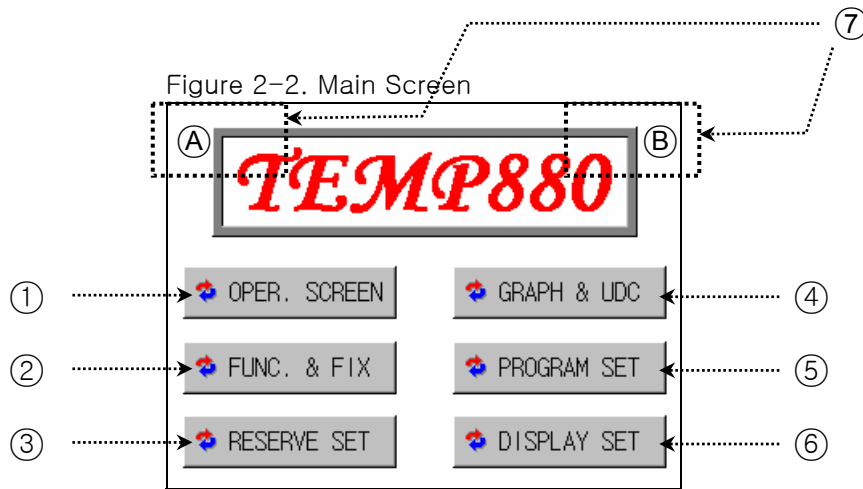

No.	Instruction	Contents	Additional Explanation
①	Operation Screen	Shifts to operation screen.	► Refer to 2.6 OPERATION SCREEN
②	Motion Setting	Shifts to function and fixed setting screen.	► Refer to 2.7 OPERATION SETTING
③	Reserved Setting	Shifts to present time and reserved setting screen.	► Refer to 2.8 RESERVE SETTING
④	Graph Display	Shifts to graph display and graph record setting screen.	► Refer to 2.9 GRAPH AND GRAPH RECORD SETTING
⑤	Pattern Setting	Shifts to pattern setting menu screen.	► Refer to 2.10 PATTERN SETTING
⑥	Screen Setting	Shifts to tuning key display setting and screen light control screen.	► Refer to 2.11 DISPLAY SENNTING
⑦	Hidden Key	Shifts to system internal setting screen.	► After pressing (A), press (B) to display for 2.13 PASSWORD INPUT SCREEN ► Refer to 2.12 SYSTEM SETTING

2.6 OPERATION SCREEN

- ▶ Displays condition for product operation and information.

2.6.1 PROGRAM STOP SCREEN

Figure 2-3. Program Stop -1st screen(General)

Figure 2-4. Program Stop

-1st screen(heating/cooling)

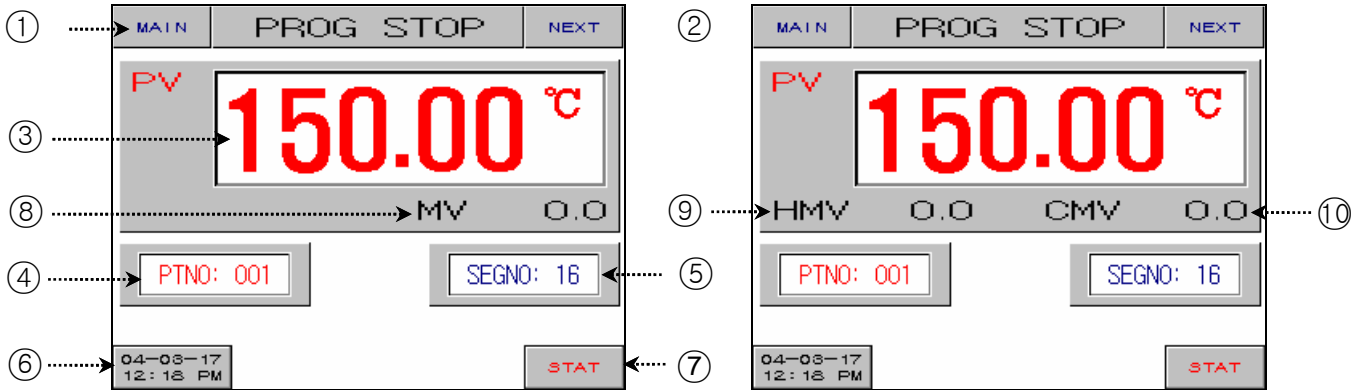

No.	Instruction	Contents	Additional Explanation
①	Main Button	Shifts to <u>2.5 MAIN SCREEN.</u>	
②	Next Button	Shifts to (Figure2-5).	▶ Used only forTEMP880
③	Present Temp.	Displays present temperature.	▶ Proper sensor type should be set up in <u>2.12.1 INPUT AND INPUT COMPENSATION SETTING</u>
④	Pattern No.	Displays present pattern numbers.	▶ Press button to set operation pattern numbers.
⑤	Segment	Displays number of segments that are programmed in the present pattern.	▶ Input program in <u>2.10.1 EDIT PATTERN EDIT</u>
⑥	Time Button	Displays present time and if you press button, LCD screen turns off. If you wish to turn on when nothing is displayed but operated normal, press anywhere on screen.	▶ Set automatic turn off time in <u>2.7 OPERATION SETTING</u> ⚠ For long durability of the back light, ten minutes are initially set up. ▶ Set present time in <u>2.8 RESERVE SETTING</u>
⑦	Operation Button	Displays a confirm box to start program operation.	▶ Refer to (Figure2-5)
⑧	Temp. Output	Displays temperature control output (General Control)	▶ During operation stop, heating standard control is generated. (H.PRESET OUTPUT)
⑨	HMV	Displays heating control output.(Heating/Cooling Control)	
⑩	CMV	Displays cooling control output.(Heating/Cooling Control)	▶ During operation stop, cooling standard control is generated. (C.PRESET OUTPUT)

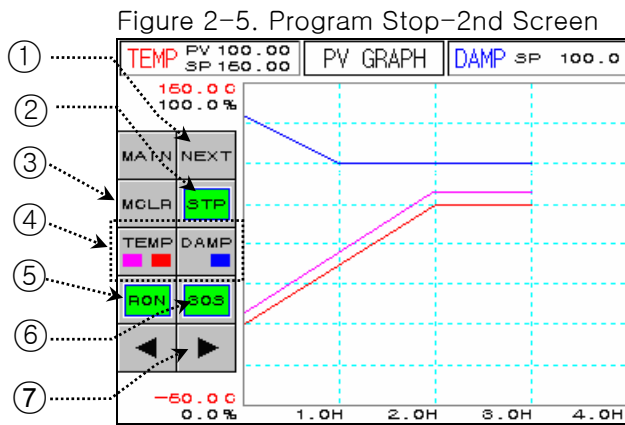

☞ Figure 2-5 is only used for TEMP880.

No.	Instruction	Contents	Additional Explanation
①	Next Button	Shifts to (Figure2-3)	
②	STP/RPT Button	Select graph display state.	<ul style="list-style-type: none"> ▶ STP : Stops after recording data for 8 days if saving period is 60 seconds, and for 4days if saving period is 40 seconds. ▶ RPT : Continuously record. Records recent data for 8 days if saving period is 60 seconds, and 4 days if saving period is 30 seconds.
③	Delete Button	Delete graph display data.	
④	Graph Display	Display temperature(PV,SP), Damp(SP)	<ul style="list-style-type: none"> ▶ Display temperature PV pink ▶ Temperature SP : display red. ▶ Damp SP : display blue
⑤	RON/ROF Button	Select graph display save.	<ul style="list-style-type: none"> ▶ Save RON : PV Graph ▶ Do not save ROF : PV Graph
⑥	30S/60S Button	Select graph save cycle.	<ul style="list-style-type: none"> ▶ Save 30S : 30sec cycle ▶ Save 60S : 60sec cycle
⑦	Back/Next Button	Shifts to back/next stage of X axis (time scale)	

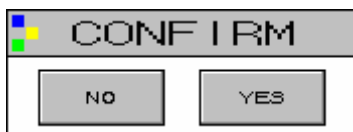

MOTION CONFIRM WINDOW

☞ This window reconfirms the motion when you press a certain button.

Ex) Program stop (or stationing) ↔ Program operation (or stationing)
 HOLD, STEP, TUNING OFF ↔ HOLD, STEP, TUNING ON,
 PATTERN COPY, PATTERN DELETE, AND ETC.

Figure 2-6. Program Stop
- Operation performing confirm

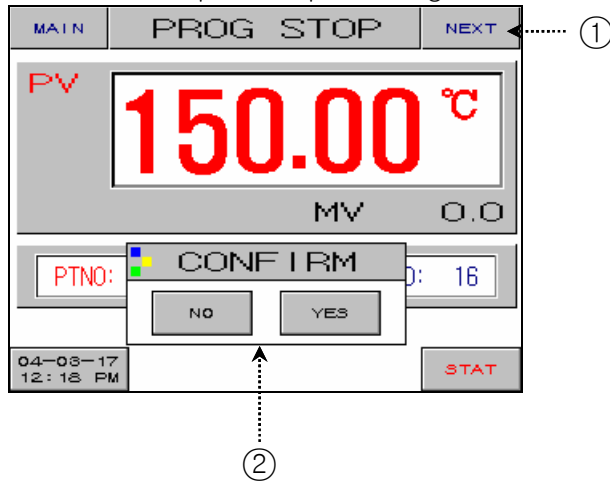

Figure 2-7. Program Stop - Pattern end

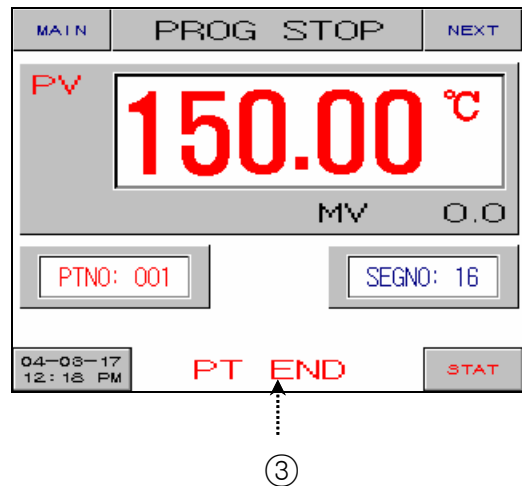
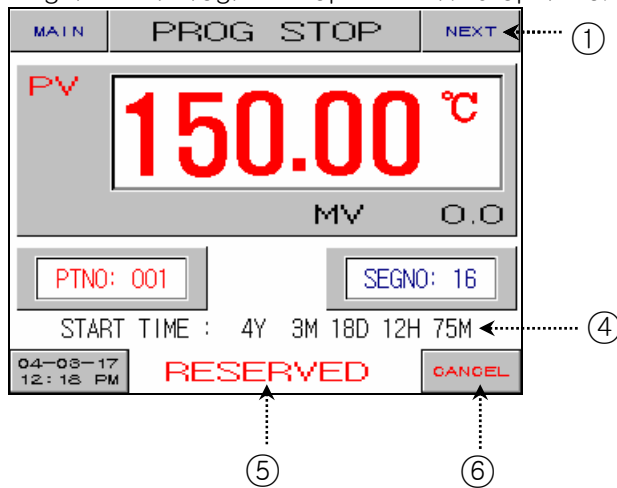

Figure 2-8. Program Stop - Reserved operation



No.	Instruction	Contents	Additional Explanation
①	Next Button	Shifts to (Figure2-5).	▶ Used only forTEMP880
②	Action Confirm Window	Asks if you wish to perform program operation.	▶ Operation starts if you press "YES". If you press "NO", it restores as Figure 2-3.
③	Pattern End	Blinks when set program ends.	▶ Disappears if you press anywhere on the screen. ✎ Even though relay and time, which are "PTEND" parameter are set in 2.12.5 DO CONFIG SET, relay is turned off when message disappears.
④	Start Time	Displays start time for reserved operation.	
⑤	Reservation	Blinks if reserved operation is set.	▶ Set operation pattern numbers by pressing the button.
⑥	Cancel Button	Cancels reserved operation state.	▶ If you press the button reserved operation is canceled and return as Figure 2-3.

2.6.2 PROGRAM RUN SCREEN

Figure 2-9. Program Operation(Standard) -1st screen

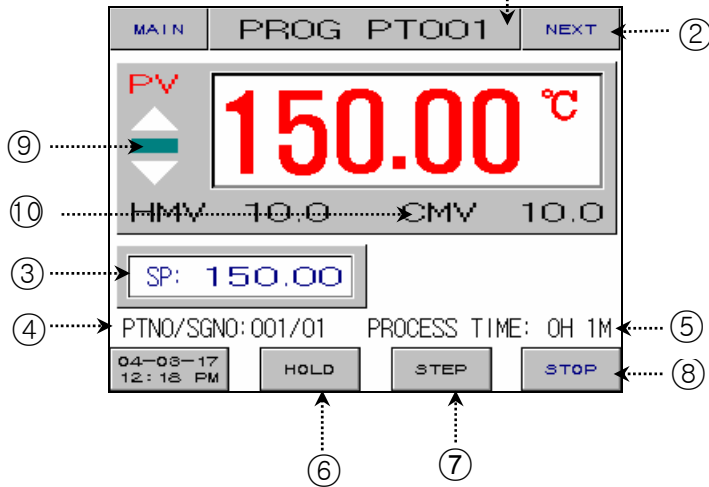
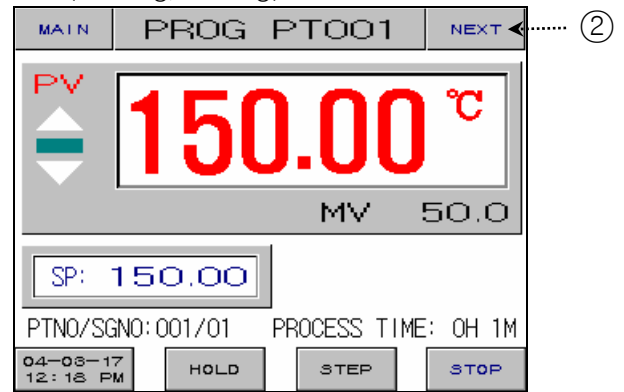

Figure 2-10. Program Operation (heating/cooling) - 1st screen



No.	Instruction	Contents	Additional Explanation
①	Operation Test Name	Displays name of pattern presently operation.	▶ Refer to 2.10.6 PATTERN NAME SETTING
②	Next Button	Shifts to Figure 2-11.	
③	Temperature Setting Value	Displays the set point of temperature.	▶ Refer to 2.10.1 PATTERN EDIT SCREEN and enter operation set point.
④	Pattern/Segment	Displays number of pattern and segment presently operation.	
⑤	Operation Time	Displays operation time current presently operation.	
⑥	Hold Button	Hold on to the set point of the present temperature or hold it off.	▶ HOLD ON : "HOLD" of the button changes into red color.
⑦	Step Button	End the present segment and shifts to the next segment.	
⑧	End Button	Displays a confirming box to end the program operation.	
⑨	Temperature Condition Sign Lamp	Displays the direction of pattern.	▶ Refer to 2.12.5 DO CONFIG
⑩	Temperature Output	Displays control output point of the present temperature. (general control)	
⑪	HMV	Displays control output point of the present heating. (heating/cooling control)	▶ Displays when setting cool output type at 2.12.21 CONTROL OUTPUT SETTING
⑫	CMV	Displays control output point of the present cooling. (heating/cooling control)	

Figure 2-11. Program Operation – 2nd Screen

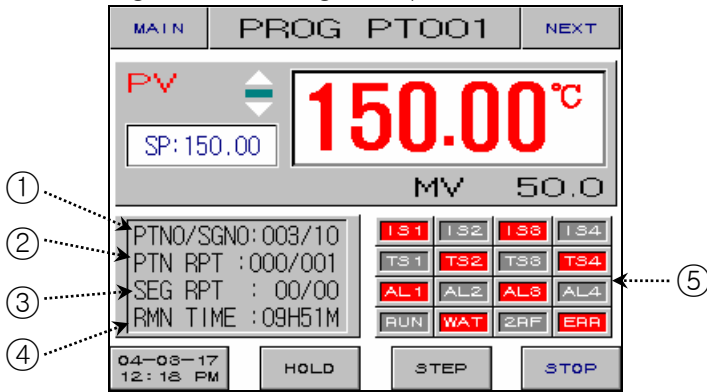

Figure 2-12. Program Operation – 3rd Screen

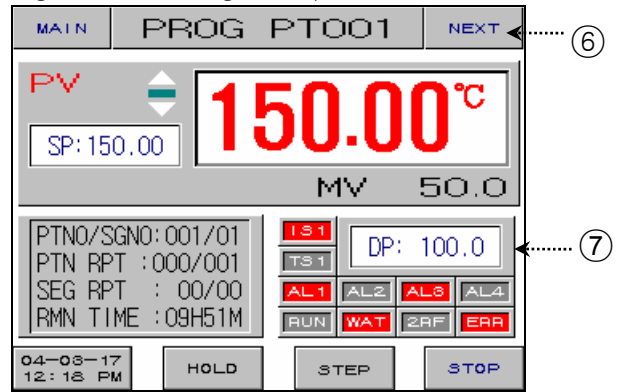
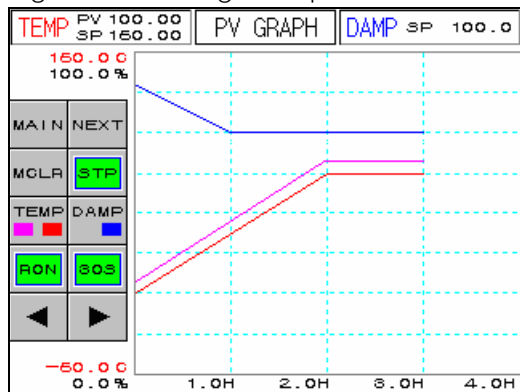

Figure 2-13. Program Operation – 4th Screen



☞ Figure 2-13 is only used for TEMP880.

No.	Instruction	Contents	Additional Explanation
①	Operation Pattern	Displays the present pattern and segment number.	
②	Pattern Repetition	Displays pattern repetition condition. 003(number of repetitions) /010(total repetitions)	▶ Refer to <u>2.10.2 REPEAT SETTING</u>
③	Segment Repetition	Displays segmentation part repetition condition. 03 number of repetitions) /10(total repetitions)	
④	Remaining Time	Displays remaining time of the present segment.	
⑤	Condition Sign Lamp	ON : Showing red light OFF : Showing dark grey light	▶ Refer to <u>2.12.8 INITIAL DISPLAY AND STATUS DISPLAY LAMP SETTING</u> ☞ Able to display total 16 lamps. But DAMP can display 10 lamps.
⑥	Next Button	Shifts to Figure 2-13.	▶ Used only for TEMP880.
⑦	Supporting Output	Displays supporting output when setting DISP.	▶ Refer to <u>2.7 OPERATION SETTING</u>

2.6.3 FIX STOP SCREEN

Figure 2-14. Fix Stop (Standard)

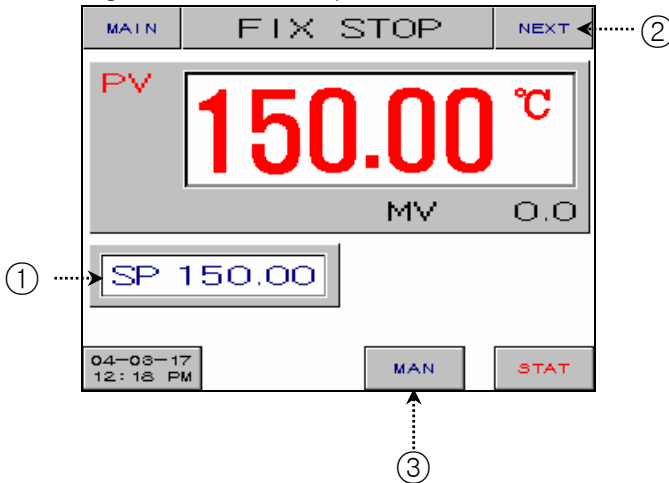

Figure 2-15. Fix Stop (heating/cooling)

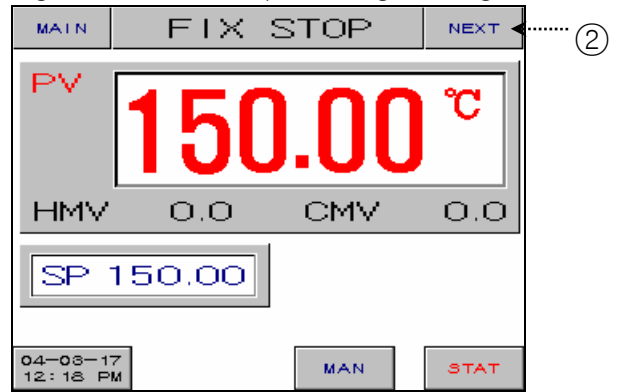

Figure 2-16 Fix Stop -Operation Motion

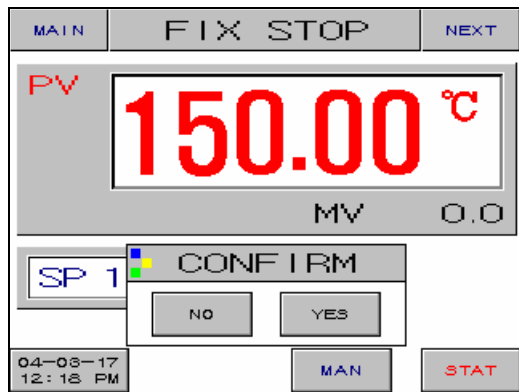
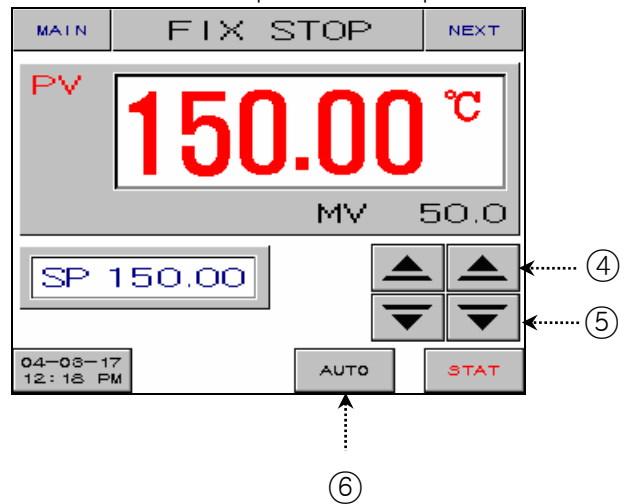

Figure 2-17. Fix Stop -Output Manual Operation



No.	Instruction	Contents	Additional Explanation
①	Temperature Set Point	Displays and sets the set point of temperature.	▶ Refer to 2.2 SET POINT INPUT METHOD and enter set point for operation.
②	Next Button	Shifts to Figure 2-20.	▶ TEMP850 is not applied.
③	Control Output Manual Operation	Enables the control output to be operated manually.	▶ Converts to output manual operation as Figure 2-15.
④	UP Key	This is key is used to output when control output is operated manually.	
⑤	DOWN Key	This is key is used to output when control output is operated manually.	
⑥	Control Output Automatic Output	Control the control output automatically.	▶ Converts to fixed stop screen Figure 2-12.

Figure 2-18. Fix Stop- Fix operation at the end

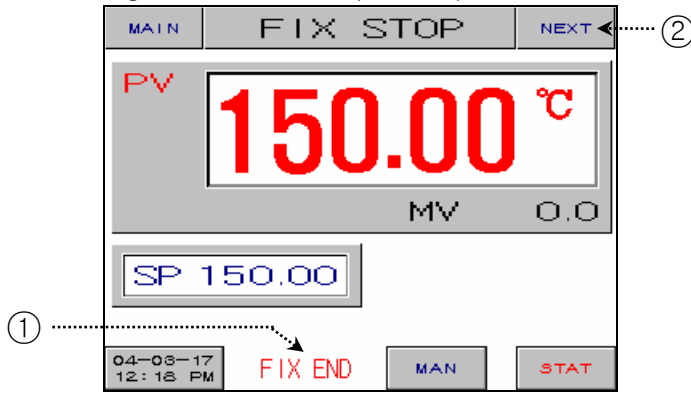
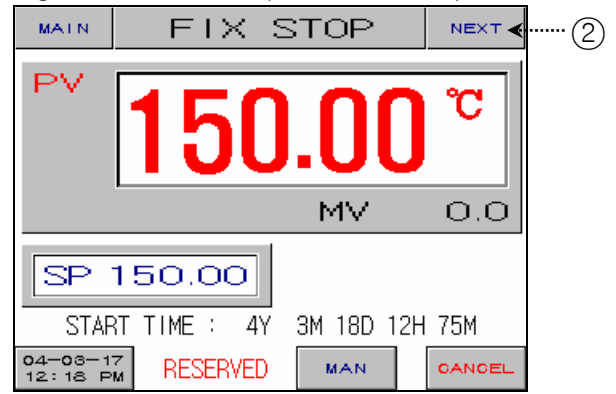
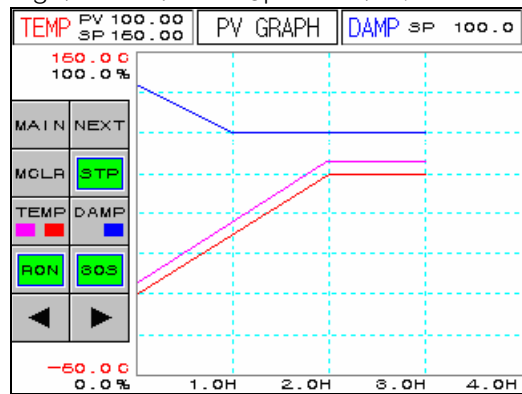

Figure 2-19. Fix Stop - Reserved operation



No.	Instruction	Contents	Additional Explanation
①	Fix Operation End	Blinks when operation is ended after set time is passed.	<ul style="list-style-type: none"> Refer to 2.7 MOTION SETTING Disappears if press anywhere on screen.
②	Next Button	Shifts to Figure 2-20.	<ul style="list-style-type: none"> Used only for TEMP880.

Figure 2-20. Fix Stop - 2 screen



☞ Figure 2-20 is used only for TEMP880.

2.6.4 FIX RUN SCREEN

Figure 2-21. Fix Run -1screen (general)

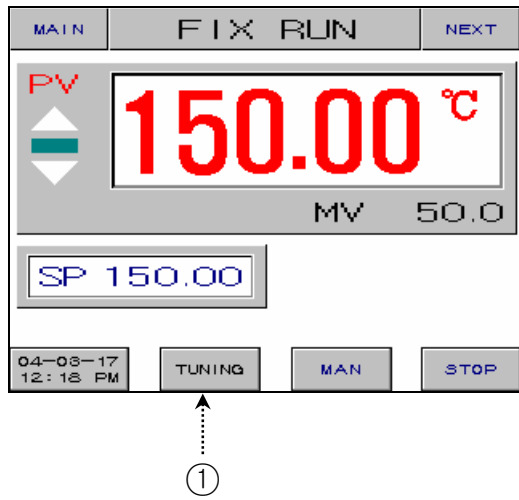
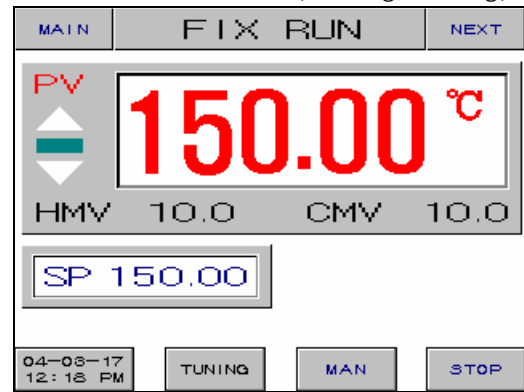

Figure2-22. Fix Run -1screen (heating/cooling)



No.	Instruction	Contents	Additional Explanation
①	Tuning	Turn on the auto tuning or turn it off at the present temperature set point.	▶ “TUNING” of the button changes into red color for auto tuning.

Figure 2-23. Fix Run – 2 screen

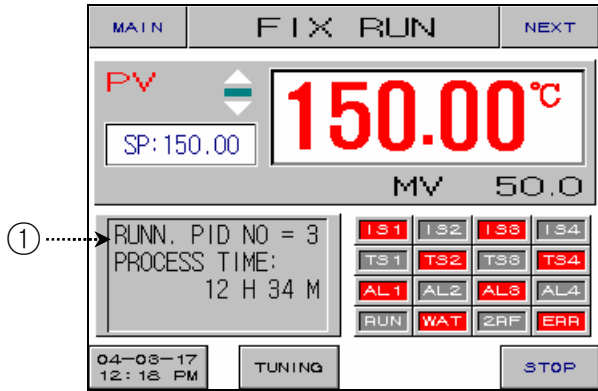

Figure 2-24. Fix Run- 3 screen

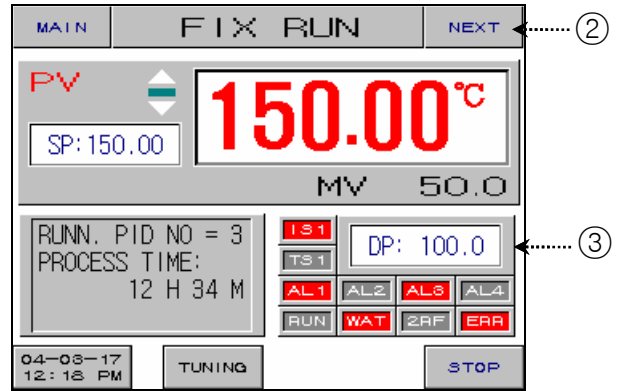
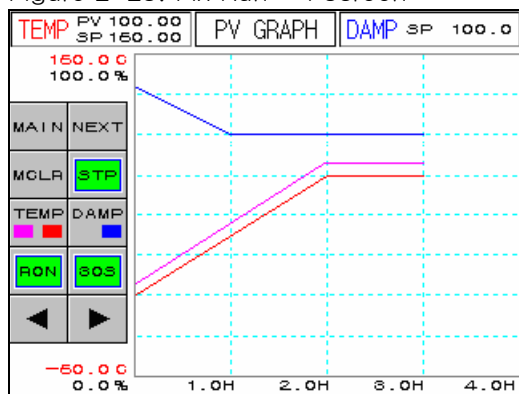

Figure 2-25. Fix Run – 4 screen



☞ Figure 2-25 is used only for TEMP880

No.	Instruction	Contents	Additional Explanation
①	PID group number at operation	Displays PID group number applied for the present operation.	▶ Refer to 2.12.4 PID SETTING
②	Next Button	Shifts to Figure 2-25.	▶ Used only for TEMP880
③	Auxiliary Output	When establishing Displays supplementary output to “DISP”, establish and indicate supplementary output established on patter.	▶ Refer to 2.7 MOTION SETTING

2.7 OPERATION SETTING SCREEN

► This is a screen for additional set for additional function or fix operation.

Figure 2-26. Operation Setting-1 Screen

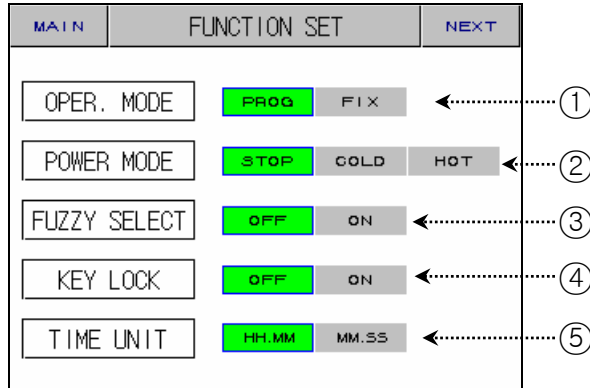
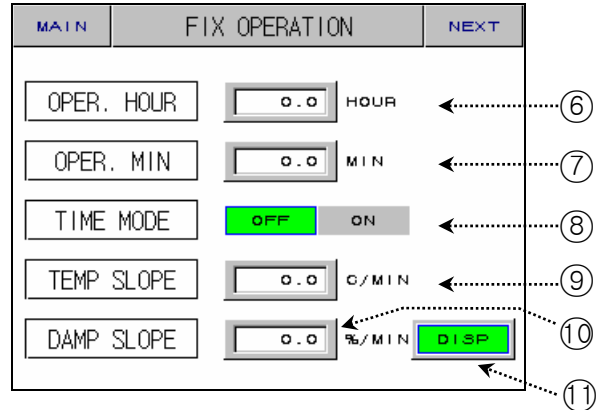

Figure 2-27. Operation Setting-2 Screen



No.	Instruction	Contents	Additional Explanation																
①	Motion Mode	Selects operation mode	<ul style="list-style-type: none"> ► PROG : 2.6.1 PROGRAM STOP ► FIX : 2.6.3 FIX RUN STOP ☞ Cannot switch during operation. 																
②	Outage Mode	Selects operation mode for recovering from outage. <ul style="list-style-type: none"> ► Recognizes outage, which lasts longer than three seconds. ► If recovers from outage within three seconds, automatically restored as HOT state. 	<ul style="list-style-type: none"> ► Recovering from outage. <table border="1"> <thead> <tr> <th>Before power failure</th> <th>PROG/FIX STOP</th> <th>PROG RUN</th> <th>FIX RUN</th> </tr> </thead> <tbody> <tr> <td>STOP</td> <td>PROG/FIX STOP</td> <td>PROG STOP</td> <td>FIX STOP</td> </tr> <tr> <td>COLD</td> <td>PROG/FIX STOP</td> <td>Run from the first segment</td> <td>FIX RUN</td> </tr> <tr> <td>HOT</td> <td>PROG/FIX STOP</td> <td>Run from operation segment before outage</td> <td>FIX RUN</td> </tr> </tbody> </table>	Before power failure	PROG/FIX STOP	PROG RUN	FIX RUN	STOP	PROG/FIX STOP	PROG STOP	FIX STOP	COLD	PROG/FIX STOP	Run from the first segment	FIX RUN	HOT	PROG/FIX STOP	Run from operation segment before outage	FIX RUN
			Before power failure	PROG/FIX STOP	PROG RUN	FIX RUN													
			STOP	PROG/FIX STOP	PROG STOP	FIX STOP													
			COLD	PROG/FIX STOP	Run from the first segment	FIX RUN													
HOT	PROG/FIX STOP	Run from operation segment before outage	FIX RUN																
③	Fuzzy Setting	Settles control during the occurrence of disturbance																	
④	Locking Setting	Setting/cancel key lock.	☞ Only moving screen and canceling key lock are possible.																
⑤	Time Mode	It fixes a time unit applied to the operation of PROG.	► Sets segment time, stand by time, temperature slope setting time, time signal.																
⑥	Operation Hour(H)	Sets hour for fix operation.																	
⑦	Operation Hour(M)	Sets minute for fix operation.																	
⑧	Reserve Set	Turn on/off time function of fix operation.	<ul style="list-style-type: none"> ► OFF : Ends fix operation by pressing "STOP" button. ► ON : Operates only for set time at ⑥, ⑦, and ends operation. 																
⑨	Temperature Slope Set	Temperature up/down slope	► Increases or decreases set point with a consistent changing rate during fix operation.																
⑩	Damp Slope Set	Supporting output up/down slope																	

⑪	Damp Sign	Establish whether supplementary output indication will come out on the operation screen and pattern setup screen.	
---	-----------	---	--



FUZZY OPERATION

NOTE

- ▶ If load changes intensely and set point frequently changes, overshoot may occur. Fuzzy can control overshoot effectively.
- ▶ Internal motion of fuzzy function
 - ① When pointer value (PV) gets close to set point (SP), supporting set point (SUPER SP) starts calculating.
 - ② Treat this calculated value from the previous step as set point and calculate control output (MV).
- 👁 **Overshoot is repressed.**

▶ Changes of pointer value (PV) according to the function of fuzzy

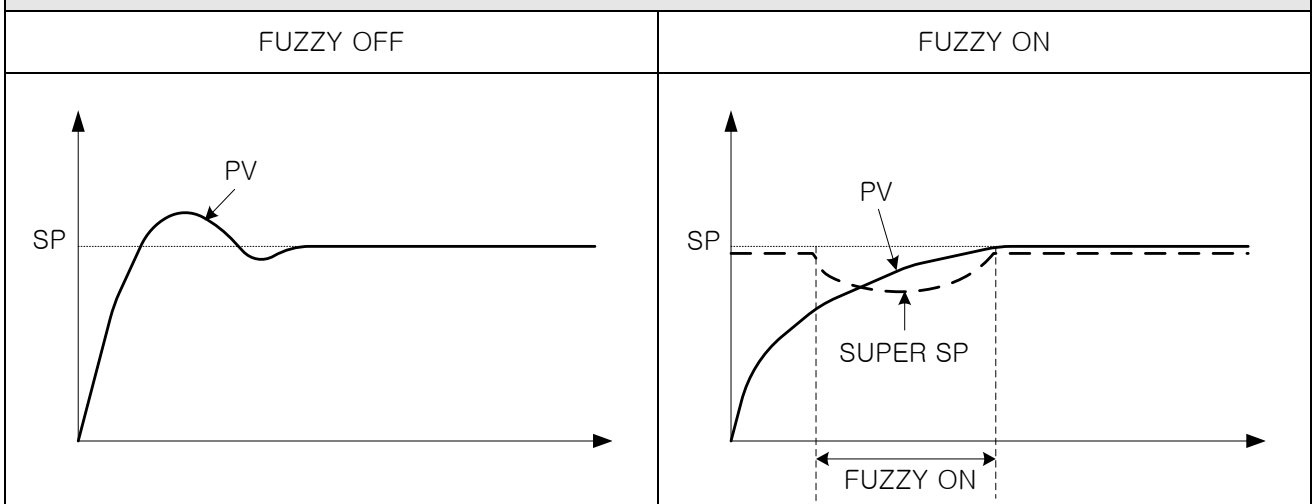



SLOPE OPERATION

- ▶ When changing target set point(TSP), it changes from the present pointer value(PV) to TSP with consistent changing rate.

▶ SLOPE OPERATION

- ▶ OPER. MODE
→ FIX RUN
- ▶ TEMP SLOPE
→ 20.0 °C/MIN

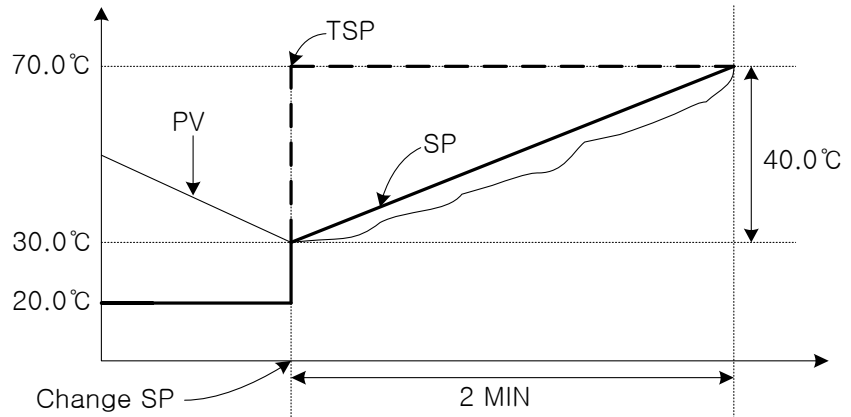

[Changed SP(TSP) - PV at the point of time of changing SP PV] with a slope of 20.0°C in every minute.
 → (70.0 - 30.0) °C = 40.0°C Changes 40 degree with a slope of 20.0°C in every minute.
 ➤ Increases SP from 30.0°C to 70.0°C with a consistent changing rate for two minutes .

2.8 RESERVE SETTING SCREEN

► This is a screen which sets present time and reserve time and operation.

Figure 2-28. Reserve setting screen

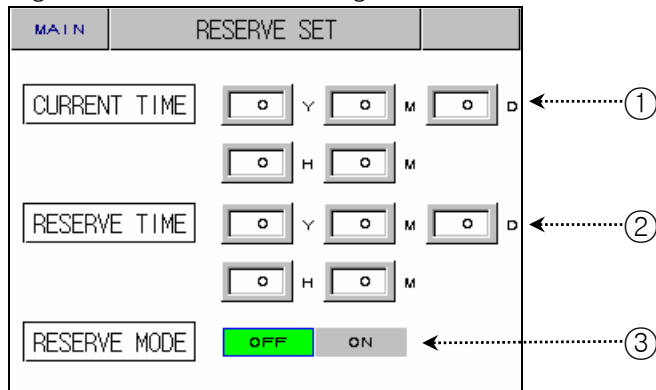

No.	Instruction	Contents	Additional Explanation
①	Present Time	Sets and displays the present time(Year, month, day, hour, minute)	
②	Reserve Time	Sets and displays reserve operation time (Year, month, day, hour, minute).	
③	Reserve Set	Turns on/off reservation.	► Refer to Figure 2-8, Figure 2-19

2.9 GRAPH SETTING SCREEN

- ▶ This is a screen which displays graphs for the entered pattern at 2.10.1 PATTERN EDIT
- ▶ This screen sets graph record (UDC100 : USB saving device)
- 🔍 Graph record function works after UDC100(USB saving device) is purchased.

Figure 2-29. Graph Display Screen

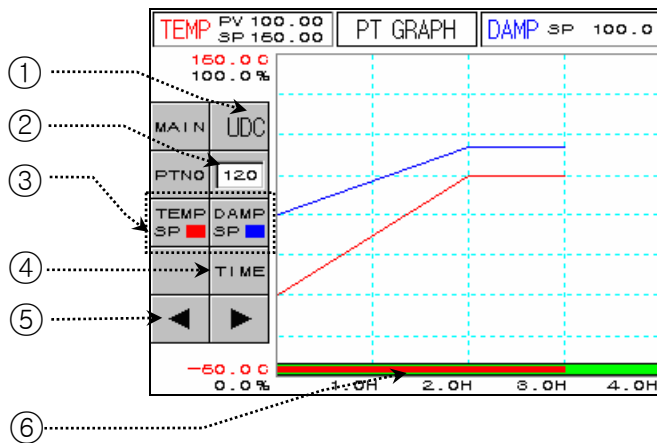

No.	Instruction	Contents	Additional Explanation																																													
①	UDC Button	Shifts to UDC set screen.	▶ UDC Option use																																													
②	Pattern Number	Sets pattern number to graph.																																														
③	Graph Indicator	Selects temperature and Damp. Then displays them.	▶ Red line is temperature. Blue line is Damp.																																													
④	Time Button	Changes X axis (time scale) of graph.	▶ Time scale changes as you press the button. <table border="1" style="margin-left: 20px;"> <tr> <td>0H</td><td>1H</td><td>2H</td><td>3H</td><td>4H</td> </tr> <tr> <td colspan="5" style="text-align: center;">↓</td> </tr> <tr> <td>0H</td><td>3H</td><td>6H</td><td>9H</td><td>12H</td> </tr> <tr> <td colspan="5" style="text-align: center;">↓</td> </tr> <tr> <td>0H</td><td>6H</td><td>12H</td><td>18H</td><td>24H</td> </tr> <tr> <td colspan="5" style="text-align: center;">↓</td> </tr> <tr> <td>0H</td><td>12H</td><td>24H</td><td>48H</td><td>72H</td> </tr> <tr> <td colspan="5" style="text-align: center;">↓</td> </tr> <tr> <td>0H</td><td>24H</td><td>48H</td><td>72H</td><td>96H</td> </tr> </table>	0H	1H	2H	3H	4H	↓					0H	3H	6H	9H	12H	↓					0H	6H	12H	18H	24H	↓					0H	12H	24H	48H	72H	↓					0H	24H	48H	72H	96H
0H	1H	2H	3H	4H																																												
↓																																																
0H	3H	6H	9H	12H																																												
↓																																																
0H	6H	12H	18H	24H																																												
↓																																																
0H	12H	24H	48H	72H																																												
↓																																																
0H	24H	48H	72H	96H																																												
⑤	Back/Next Button	Shifts to back/next stage of X axis (time scale).																																														
⑥	Time Graph	Displays the time progress of the program operation.	▶ Displays red as time progresses.																																													

Figure 2-30. Graph Record Setting Screen

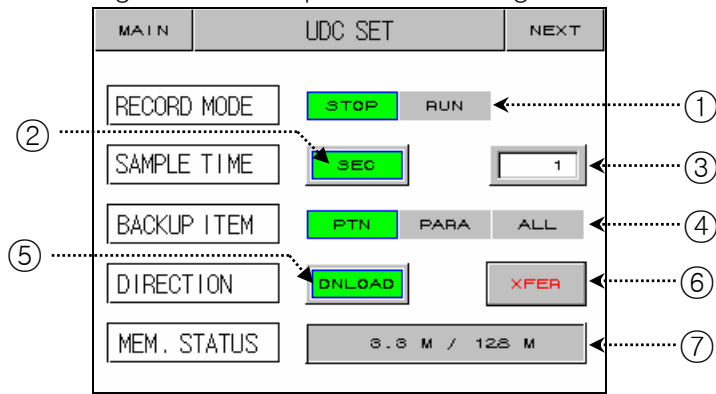

No.	Instruction	Contents	Additional Explanation
①	Motion Mode	Activate or stop the graph record	<ul style="list-style-type: none"> ▶ “RUN” only during program operation and fix operation. ▶ Switched to “STOP” when program operation and fix operation stops.
②	Time Unit	Selects time saving unit.	
③	Record Cycle	Sets recording cycle.	
④	Transmission Object	Selects transmission object.	<ul style="list-style-type: none"> ▶ PTN : Selects parameter for pattern set, repetition set, test name input. ▶ PARA : Selects all parameters except the ones selected at PTN and communication related parameters. ▶ ALL : Selects all parameters except communication related ones.
⑤	Transmission Direction	Selects upload/download.	<ul style="list-style-type: none"> ▶ Upload : Transmits selected object from UDC100 to TEMP880. ▶ Download : Transmits selected object from TEMP880 to UDC100.
⑥	Transmission	Transmits data	<ul style="list-style-type: none"> ▶ It is impossible to switch screen during transmission.
⑦	Memory Use	Displays currently using memory.	

☞ To use UDC100, format the memory stick to FAT16.

2.10 PATTERN SETTING SCREEN

► This is a center of the screen which sets parameter related to program operation.

Figure 2-31. Pattern Setting Screen

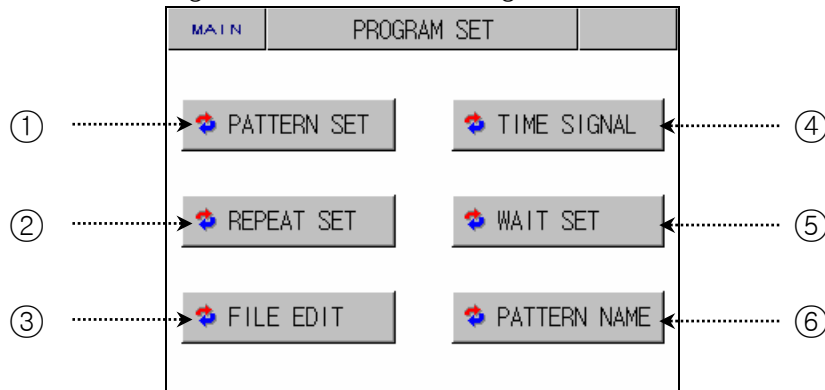

No.	Instruction	Contents	Additional Explanation
①	Pattern Set	Shifts to pattern edit screen.	► Refer to 2.10.1 EDIT PATTERN
②	Repetition Set	Shifts to pattern and segment repetition set edit screen.	► Refer to 2.10.2 REPEAT SET
③	File Edit	Shifts to the screen which sets copy and delete of pattern screen.	► Refer to 2.10.3 EDIT FILE
④	Time Signal	Shifts to time signal set screen.	► Refer to 2.10.4 TIME SIGNAL SET
⑤	Stand By Set	Shifts to stand by motion set screen.	► Refer to 2.10.5 WAIT OPERATION SET
⑥	Test Order Input	Shifts to test name set screen.	► Refer to 2.10.6 PATTERN NAME SET

2.10.1 EDIT PATTERN SCREEN

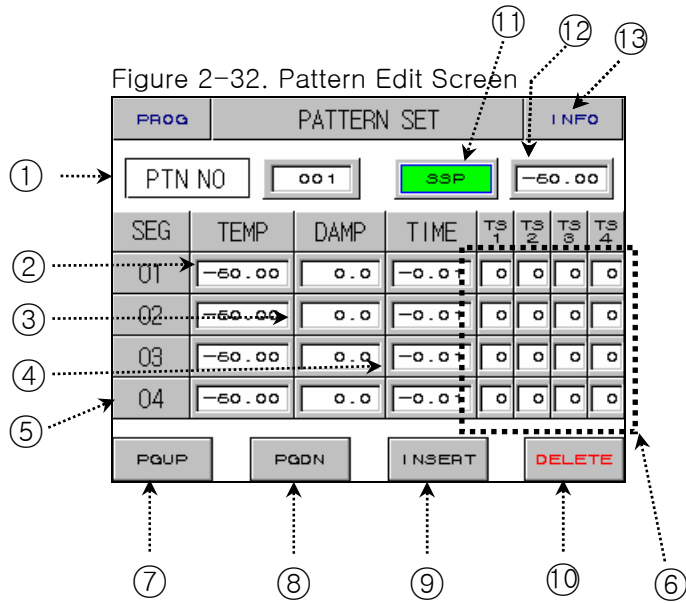
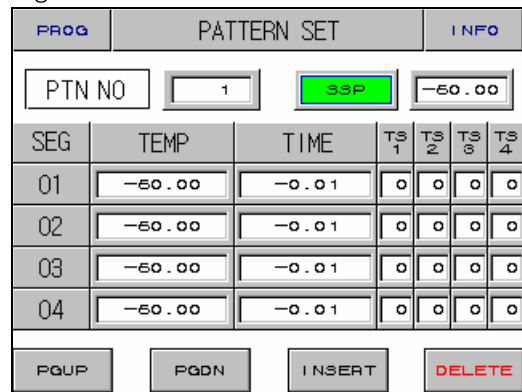

Figure 2-33. Pattern Edit Screen



This is a screen when the operation setup screen (P.33 Figure 2-27) is changed to hide.

No.	Instruction	Contents	Additional Explanation	
①	Pattern Number	Sets pattern number to program.	Refer to 2.10.2 REPETITION SET SCREEN changes with pattern number.	
②	Segment Temperature	Sets segment temperature for operation.		
③	Segment Damp	Sets segment Damp for operation.		
④	Segment Time	Set segment time for operation.	▶ How to enter time	
			Set Time	Actual Set Point
			OFF(no use)	-0.01
			1 min	0.01
			30 min	0.30
1 hour	1.00			
⑤	Segment Number	To insert or delete segment, press this button and select segment.	▶ Selected segment becomes red when you press the button. Then, you may insert or delete the segment.	
⑥	Time Signal	Sets segment time signal for operation.	▶ Refer to 2.10.1.4 HOW TO SET TIME SIGNAL	
			▶ Refer to 2.10.4 HOW TO SET TIME SIGNAL	
⑦	Back Button	Shifts the screen up by 4 segment units.	▶ Refer to 2.10.1.3 SCREEN SHIFTING BY NEXT & BACK BUTTON	
⑧	Next Button	Shifts the screen down by 4 segment units.		
⑨	Segment Insert	Copies segment and inserts.	▶ Refer to 2.10.1.1 HOW TO INSERT SEGMENT	
⑩	Segment Delete	Deletes segment.	▶ Refer to 2.10.1.2 HOW TO SEGMENT DELETE	
⑪	Start condition	Sets the start condition for the program operation.		
⑫	Start Set Point	Sets starting set point for the program operation whose starting condition is SSP.		
⑬	Information Button	Shifts to the file information screen.	▶ Refer to 2.10.1.5 FILE INFORMATION SCREEN	

2.10.1.1 HOW TO INSERT SEGMENT

- ▶ Inserting a segment between Segment “02” and Segment “03”.

Diagram 2-34. Before Inserting Segment

SEG	TEMP	DAMP	TIME	T ₁ ^S	T ₂ ^S	T ₃ ^S	T ₄ ^S
01	50.00	90.0	8.00	00	00	00	00
02	40.00	90.0	8.00	01	04	05	06
03	-50.00	0.0	-0.00	00	00	00	00
04	-50.00	0.0	-0.01	00	00	00	00

Diagram 2-35. After Inserting Segment

SEG	TEMP	DAMP	TIME	T ₁ ^S	T ₂ ^S	T ₃ ^S	T ₄ ^S
01	50.00	90.0	8.00	00	00	00	00
02	40.00	90.0	8.00	01	04	05	06
03	40.00	90.0	8.00	01	04	05	06
04	-50.00	0.0	-0.01	00	00	00	00

- 1) If you press dotted box above Diagram2-34, the letter “02” becomes red.
- 2) If you press Insert (Ⓣ) Button in Diagram 2-32. Pattern Edit Screen, segment with a same setting point of Segment “02” will be added.

2.10.1.2 HOW TO DELETE SEGMENT

- ▶ Deleting Segment “02”.

Figure 2-36. Before Deleting Segment

SEG	TEMP	DAMP	TIME	T ₁ ^S	T ₂ ^S	T ₃ ^S	T ₄ ^S
01	50.00	90.0	8.00	00	00	00	00
02	40.00	90.0	8.00	01	04	05	06
03	60.00	80.0	0.30	02	00	00	00
04	-50.00	0.0	-0.01	00	00	00	00

Figure 2-37. After Deleting Segment

SEG	TEMP	DAMP	TIME	T ₁ ^S	T ₂ ^S	T ₃ ^S	T ₄ ^S
01	50.00	90.0	8.00	00	00	00	00
02	60.00	80.0	0.30	02	00	00	00
03	-50.00	0.0	-0.01	00	00	00	00
04	-50.00	0.0	-0.01	00	00	00	00

- 1) If you press dotted box above Figure2-36, the letter “02” becomes red.
- 2) If you press Delete (Ⓛ) Button in Figure 2-32. Pattern Edit Screen, Segment “02” will be deleted, and the next segment of deleted segment will move to the spot.

 **Case where segment cannot be inserted or deleted**

NOTE

- ☞ When setting point of segment that you wish to insert or deleted is an initial value, segment cannot be inserted or deleted.
- ☞ Segment cannot be inserted or deleted during program operation.

2.10.1.3 의한 SCREEN SHIFTING ACCRORDING TO NEXT & BACK BUTTON

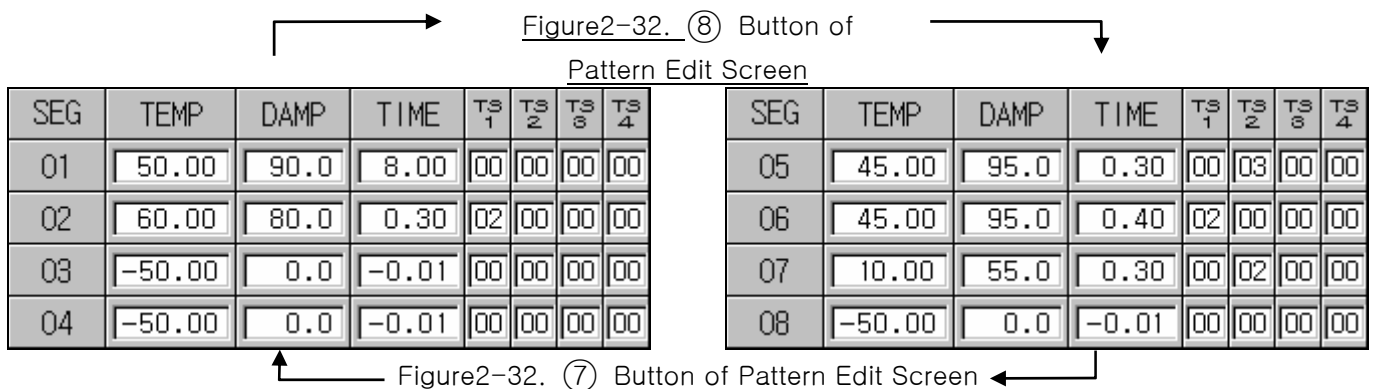

2.10.1.4 HOW TO SET TIME SIGNAL

▶ Setting up S Time Signal2 of Segment “01” as TYPE “1”, Time Signal3 as TYPE “2”, and Time Signal4 as TYPE “7”.

Figure 2-38. Before Time Signal Setting

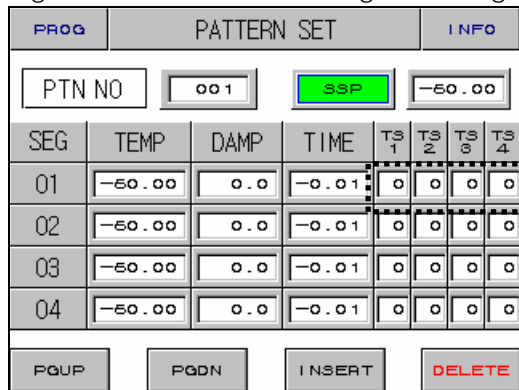
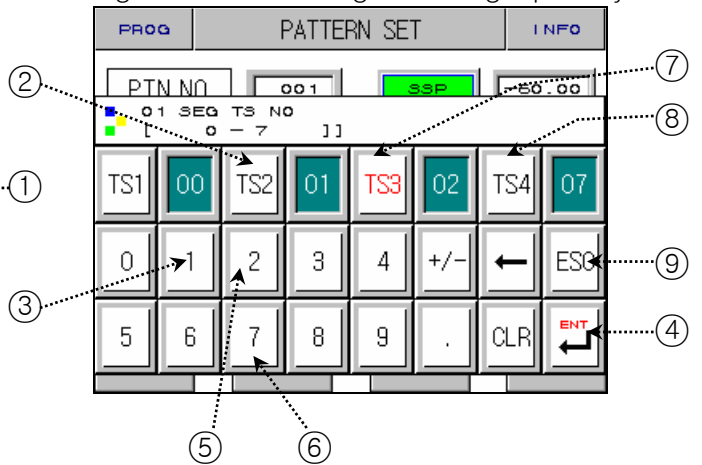

Figure 2-39. Time Signal Setting Input Key



- 1) If you press anywhere of ① on the previous screen of Figure 2-38. Time Signal Setting, Figure2-39. Time Signal Setting Input Key will be displayed.
- 2) Press ②→③→④→⑦→⑤→④→⑧→⑥→④→⑨ Button as Figure2-39 Time Signal Setting Input Key, to set Time Signal.
- 3) 🖱️ For kinds of entered Time Signal, refer to 2.10.4 Time Signal Setting.

2.10.1.5 FILE INFO SCREEN

▶ It displays number of set Pattern and Segment.

Figure 2-40. File Information Screen

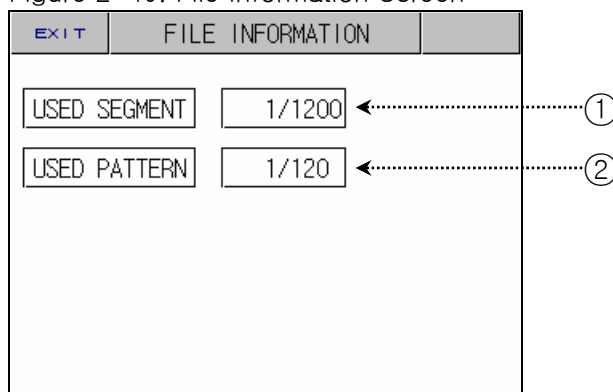

No.	Instruction	Contents	Additional Explanation
①	Segment Use	Displays number of segment currently set.	▶ number of segments currently set /max number of possible setting segment
②	Pattern Use	Displays number of pattern currently set.	▶ number of patterns currently set /max number patterns of possible setting segment



Program Operation Start

NOTE

- ▶ Program Operation
Start is done according to the setting of STC (Start Code).

1. Setting Point Preferred Program Operation (STC = SSP)

- ▶ When program operation starts, SP starts from SSP and operates until SP1 under 1SEG for set time (TM1).

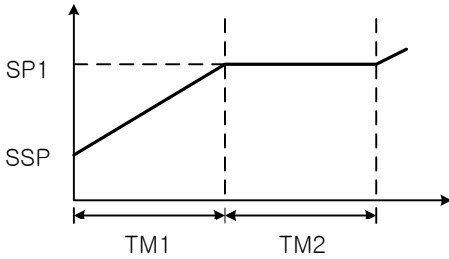

2. Slope Preferred Program Operation (STC = S.PV)

- ▶ When program operation starts, Setting Point (SP) starts from the present point value (PV) and operates until Setting Point1 (SP1) under SEG1. Based on the contents of program pattern, remaining time is calculated as time is passed till operation starting point.

① When Segment 2 is the first maintaining section

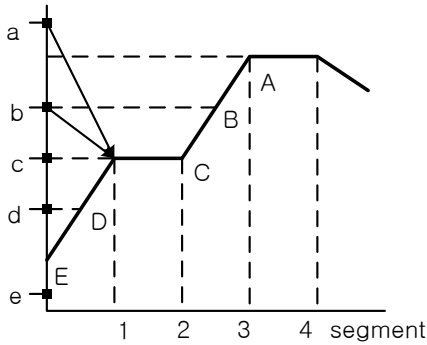

Present Pointing Value	Program Operation Start
a	C
b	C
c	C
d	D
e	E(SSP)

② When Segment 3 is the first maintaining section

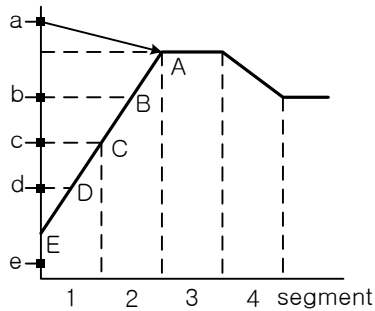

Present Pointing Value	Program Operation Start
a	A
b	B
c	C
d	D
e	E(SSP)

③ When there is no maintaining section

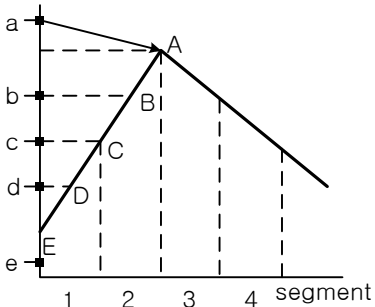

Present Pointing Value	Program Operation Start
a	A
b	B
c	C
d	D
e	E(SSP)

④ When there is only rising section without maintaining section

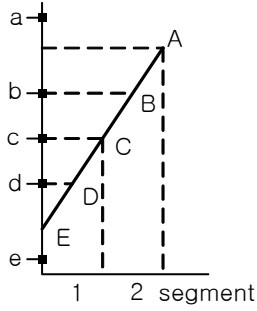

Present Pointing	Program Starting point of operation
a	Operation not started
b	B
c	C
d	D
e	E(SSP)

⑤ When maintaining section starts from Segment 1

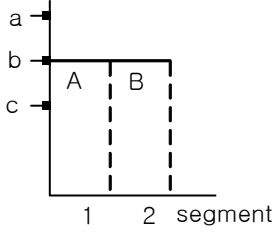

Present Pointing	Program Starting point of operation
a	B
b	B
c	A(SSP)

3. Time Preferred Program Operation (STC = T.PV)

- ▶ When program operation starts, Setting Point (SP) starts from the present pointing value regardless of slope or Starting Setting Point (SSP) and progresses till Setting Point 1 (SP1) for set time.

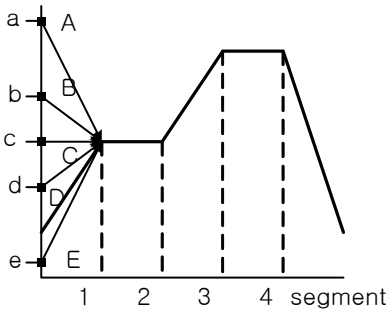

Present Pointing	Program Starting point of operation
a	A
b	B
c	C
d	D
e	E

2.10.2 REPEAT SETTING SCREEN

Figure 2-41. Repeat Setting Screen

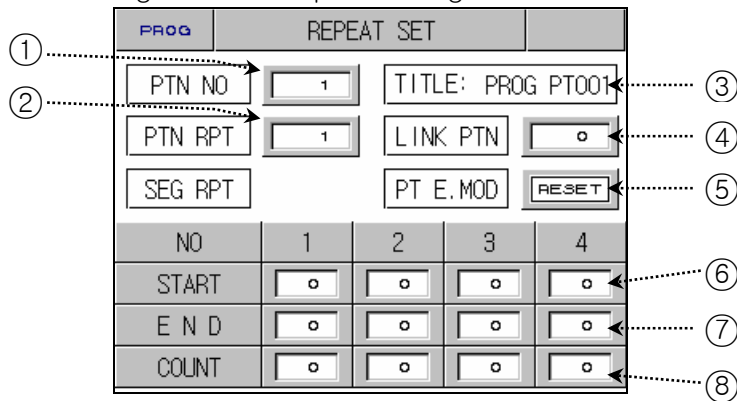

No.	Instruction	Contents	Additional Explanation
①	Pattern Number.	Sets pattern number that you wish to repeat.	☞ Changes as the pattern number of 2.10.1 Pattern Edit Screen
②	Number of Pattern Repeat	Inputs number of pattern repeating operation time.	☞ Enter "0" for repeating infinitely
③	Pattern Name	Displays set pattern name..	▶ Refer to 2.10.6 Pattern Name Setting
④	Connection Pattern	Sets the consecutive patterns when pattern operation.	
⑤	Pattern End	Decides operation mode when pattern ends.	<ul style="list-style-type: none"> ▶ End : PT END ▶ Hold : Hold at the last segment sp ▶ Fix Mode : Runs as fix mode after pattern ends ▶ Connection : Operates as it is set under link pattern after pattern ends
⑥	Start Segment	Sets segment which starts part repeat operation.	▶ Start Segment ≤ End Segment
⑦	End Segment	Sets segment which ends part repeat operation.	
⑧	Number of Segment Repeat	Sets how many times to run part repeat operation.	

2.10.2.1 PATTERN REPEAT SETTING

Pattern Repeat Setting Point	Pattern Processing Order						
<table border="1"> <tr> <td>PTN NO</td> <td>001</td> <td>TITLE: PROG PT001</td> </tr> <tr> <td>PTN RPT</td> <td>002</td> <td>LINK PTN 003</td> </tr> </table>	PTN NO	001	TITLE: PROG PT001	PTN RPT	002	LINK PTN 003	<p>▶ Repeat Pattern1 twice as it is set. Execute pattern 3, connecting pattern. ① Pattern1 → Pattern1</p>
PTN NO	001	TITLE: PROG PT001					
PTN RPT	002	LINK PTN 003					
<table border="1"> <tr> <td>PTN NO</td> <td>003</td> <td>TITLE: PROG PT003</td> </tr> <tr> <td>PTN RPT</td> <td>005</td> <td>LINK PTN 002</td> </tr> </table>	PTN NO	003	TITLE: PROG PT003	PTN RPT	005	LINK PTN 002	<p>▶ Repeat Pattern3 five times as it is set. Execute pattern 2, connecting pattern. ② Pattern3 → Pattern3 → Pattern3 → Pattern3 → Pattern3</p>
PTN NO	003	TITLE: PROG PT003					
PTN RPT	005	LINK PTN 002					
<table border="1"> <tr> <td>PTN NO</td> <td>002</td> <td>TITLE: PROG PT002</td> </tr> <tr> <td>PTN RPT</td> <td>001</td> <td>LINK PTN 000</td> </tr> </table>	PTN NO	002	TITLE: PROG PT002	PTN RPT	001	LINK PTN 000	<p>▶ Repeat Pattern2 once as it is set. Pattern ends since there is no connecting pattern. ③ Pattern 2 → Pattern Ends</p>
PTN NO	002	TITLE: PROG PT002					
PTN RPT	001	LINK PTN 000					

2.10.2.2 SEGMENT PROCESSING ORDER ACCORING TO PART REPEAT (SEGMENT REPEAT) SETTING

▶ Segment processing order is shown as below when 1Segment to 8Segment(01 → 02 → 03 → 04 → 05 → 06 → 07 →08) are set.

Example Number	Part Repeat Setting Point	Segment Processing Order												
Ex. 1	<table border="1"> <tr> <td>NO</td> <td>1</td> <td>2</td> </tr> <tr> <td>START</td> <td>02</td> <td>03</td> </tr> <tr> <td>E N D</td> <td>04</td> <td>05</td> </tr> <tr> <td>COUNT</td> <td>02</td> <td>02</td> </tr> </table>	NO	1	2	START	02	03	E N D	04	05	COUNT	02	02	<p>① 01 → 02 → 03 → 04 ② → 02 → 03 → 04 ③ → 03 → 04 → 05 ④ → 03 → 04 → 05 → 06 → 07 →08</p>
NO	1	2												
START	02	03												
E N D	04	05												
COUNT	02	02												
Ex. 2	<table border="1"> <tr> <td>NO</td> <td>1</td> <td>2</td> </tr> <tr> <td>START</td> <td>03</td> <td>02</td> </tr> <tr> <td>E N D</td> <td>05</td> <td>04</td> </tr> <tr> <td>COUNT</td> <td>02</td> <td>02</td> </tr> </table>	NO	1	2	START	03	02	E N D	05	04	COUNT	02	02	<p>① 01 → 02 → 03 → 04 → 05 ② → 03 → 04 → 05 ③ → 02 → 03 → 04 ④ → 02 → 03 → 04 → 05 → 06 → 07 →08</p>
NO	1	2												
START	03	02												
E N D	05	04												
COUNT	02	02												
Ex. 3	<table border="1"> <tr> <td>NO</td> <td>1</td> <td>2</td> </tr> <tr> <td>START</td> <td>02</td> <td>05</td> </tr> <tr> <td>E N D</td> <td>03</td> <td>06</td> </tr> <tr> <td>COUNT</td> <td>02</td> <td>02</td> </tr> </table>	NO	1	2	START	02	05	E N D	03	06	COUNT	02	02	<p>① 01 → 02 → 03 ② → 02 → 03 ③ → 05 → 06 ④ → 05 → 06 → 07 →08</p>
NO	1	2												
START	02	05												
E N D	03	06												
COUNT	02	02												
Ex. 4	<table border="1"> <tr> <td>NO</td> <td>1</td> <td>2</td> </tr> <tr> <td>START</td> <td>05</td> <td>02</td> </tr> <tr> <td>E N D</td> <td>06</td> <td>03</td> </tr> <tr> <td>COUNT</td> <td>02</td> <td>02</td> </tr> </table>	NO	1	2	START	05	02	E N D	06	03	COUNT	02	02	<p>① 01 → 02 → 03 → 04 → 05 → 06 ② → 05 → 06 ③ → 02 → 03 ④ → 02 → 03 → 04 → 05 → 06 → 07 →08</p>
NO	1	2												
START	05	02												
E N D	06	03												
COUNT	02	02												

Ex. 5	NO	1	2	① 01 → 02 → 03 → 04 → 05 → 06 ② → 02 → 03 → 04 → 05 → 06 ③ → 03 → 04 ④ → 03 → 04 → 05 → 06 → 07 → 08
	START	02	03	
	E N D	06	04	
	COUNT	02	02	
Ex. 6	NO	1	2	① 01 → 02 → 03 → 04 ② → 03 → 04 ③ → 02 → 03 → 04 → 05 → 06 ④ → 02 → 03 → 04 → 05 → 06 → 07 → 08
	START	03	02	
	E N D	04	06	
	COUNT	02	02	

2.10.3 EDIT FILE SCREEN

Figure 2-42. Edit File Screen

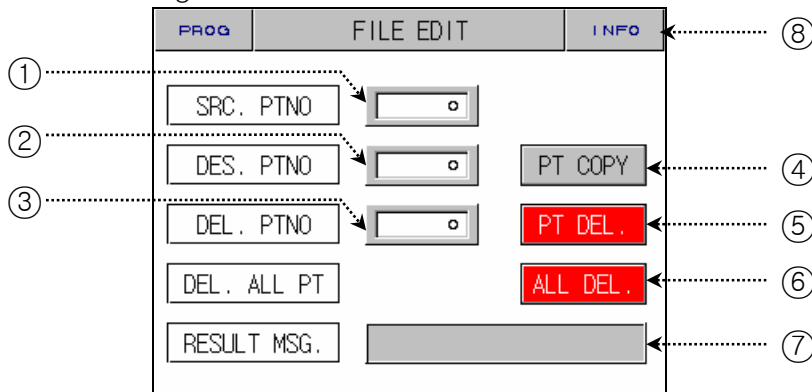

No.	Instruction	Contents	Additional Explanation	
①	Original Pattern	Sets original pattern number that you wish to copy.		
②	Target Pattern	Sets original pattern number that you target to copy.		
③	Pattern Delete	Sets original pattern number that you wish to delete.		
④	Pattern Copy Button	Copy pattern set on ① to pattern set ②.	▶ Cannot copy without setting point of the original pattern.	
⑤	Pattern Delete Button	Initialize setting point of pattern which is set in ③	✖ Cannot restore deleted pattern.	
⑥	Total Delete Button	Initialize setting point of all patterns.		
⑦	Results	Displays copy and delete info.	▶ Kind of message	
			Display message	Explanation
			Action Complete	Copy and Delete Complete
			No Pattern Info	No Pattern Setting Point
			Setting Point Input Error	Incorrect Pattern No.
			Program Operation	Pattern Operation
			Pattern Use	Copy Pattern Use
⑧	Info Button	Shifts to File Info Screen	▶ Refer to 2.10.1.5 FILE INFO Screen	

2.10.4 TIME SIGNAL SETTING SCREEN

Figure 2-43. Time Signal Setting -1Screen

PROG TIME SIGNAL SET			
TS NO(0~7)			
NO	ON TIME	OFF TIME	▲
00	TS OFF	TS OFF	
01	TS ON	TS ON	
02	00.00 HH.MM	00.00 HH.MM	
03	00.00 HH.MM	00.00 HH.MM	▼

① ②

Figure 2-44. Time Signal Setting -2 Screen

PROG TIME SIGNAL SET			
TS NO(0~7)			
NO	ON TIME	OFF TIME	▲
04	00.00 HH.MM	00.00 HH.MM	
05	00.00 HH.MM	00.00 HH.MM	
06	00.00 HH.MM	00.00 HH.MM	
07	00.00 HH.MM	00.00 HH.MM	▼

No.	Instruction	Contents	Additional Explanation
①	ON Time	Sets time from segment start point to the point signal output on/off.	<ul style="list-style-type: none"> ▶ Refer to <u>Figure2-34. Time Signal Setting Input Key</u> ▶ Setting NO: 00 → No Time Signal ▶ Setting NO: 01 → Always output at set segment. ▶ Setting NO: 02 ~ 07 → Stops output as much of on time at set segment, and off time after output occurs
②	OFF Time	Sets output stop time after time signal is off. (If segment time is still remained after stop time, time signal outputs again.)	



EXAMPLE OF TIME SIGNAL INPUT USE

▶ Program Pattern Setting Point								▶ Time Signal Setting Point			
SEG	TEMP	DAMP	TIME	TS ₁	TS ₂	TS ₃	TS ₄	NO	ON TIME	OFF TIME	
01	40.00	90.0	8.00	00	00	00	00	04	09.00 HH.MM	00.00 HH.MM	
02	40.00	90.0	8.00	01	04	05	06	05	02.00 HH.MM	09.00 HH.MM	
03	50.00	90.0	8.00	00	00	00	00	06	02.00 HH.MM	02.00 HH.MM	
04	-50.00	0.0	-0.01	00	00	00	00	07	00.00 HH.MM	00.00 HH.MM	

▶ Time Signal Motion in Segment				
Setting	Time Signal Use			
① ON Mode Setting (Time Signal NO: 01 Setting Point)	ON TIME SIGNAL1 OFF			
	SEGMENT	1 SEG(8HOUR)	2 SEG(8HOUR)	3 SEG(8HOUR)
② Segment Time < TS2 ON Time (Time Signal NO : 04 Setting Point) ⚠ ON Time doesn't affect the next segment.	ON TIME SIGNAL2 OFF			
	SEGMENT	1 SEG(8HOUR)	2 SEG(8HOUR)	3 SEG(8HOUR)
③ Segment Time < TS3 OFF Time (Time Signal NO : 05 Setting Point) ⚠ OFF Time doesn't affect the next segment.	ON TIME SIGNAL3 OFF			
	SEGMENT	1 SEG(8HOUR)	2 SEG(8HOUR)	3 SEG(8HOUR)
④ Segment Time > TS4 ON + TS4 OFF Time (Time Signal NO : 06 Setting Point) ⚠ Repeat ON and OFF in corresponding segment time.	ON TIME SIGNAL4 OFF			
	SEGMENT	1 SEG(8HOUR)	2 SEG(8HOUR)	3 SEG(8HOUR)

2.10.5 WAIT OPERATION SETTING SCREEN

Figure 2-45. Wait Operation Setting Screen

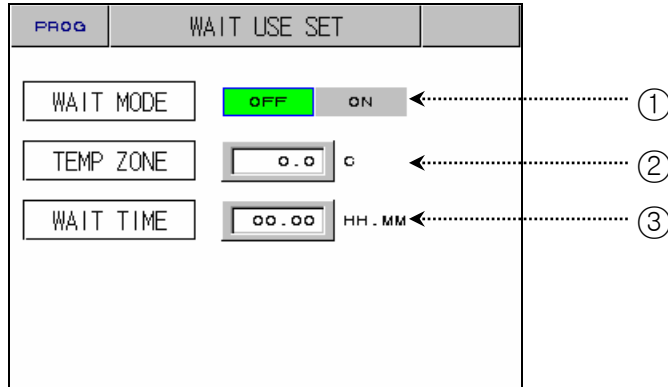

No.	Instruction	Contents	Additional Explanation
①	Wait Setting	Sets wait use.	<ul style="list-style-type: none"> ▶ Wait Use Entry Condition → When temperature cannot enter wait use set range within segment time. ▶ Wait Use Cancel Condition → When temperature enters wait use set range.
②	Temperature Range	Sets temperature range which wait use will be applied.	
③	Wait Time	Sets wait time when temperature point value (PV) does not enter wait use range.	<ul style="list-style-type: none"> ▶ If wait time is not set (00.00), it has infinite value.



Relationship Between Wait Use and Wait Time

① When wait use is canceled within wait time.

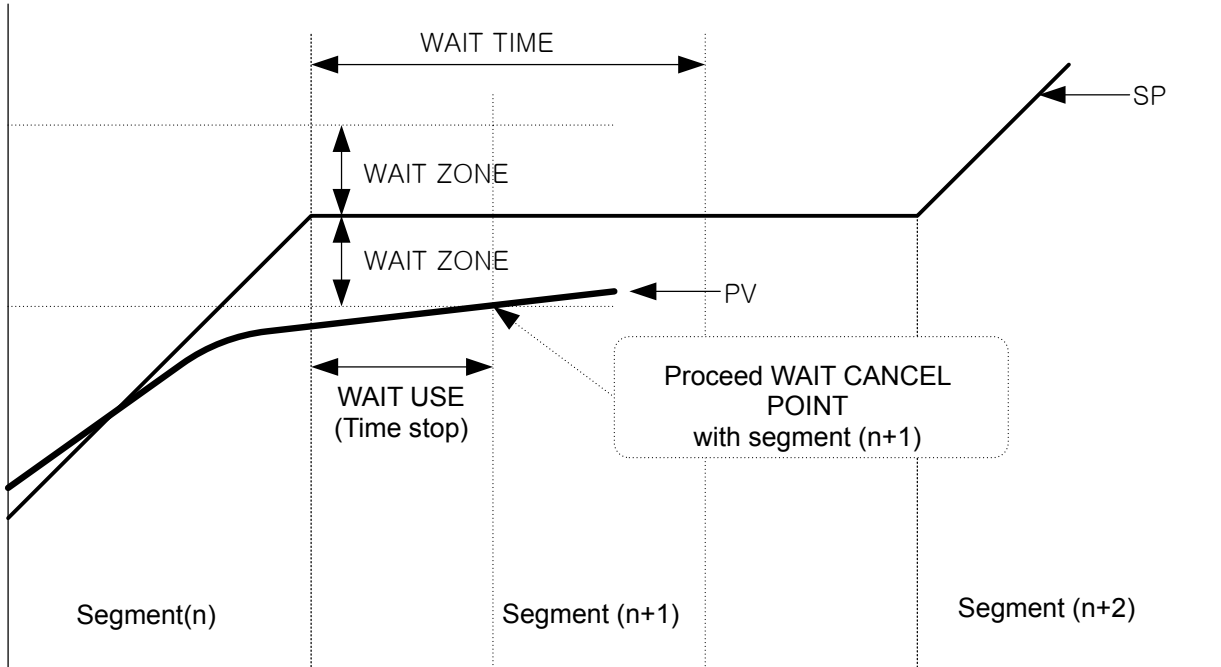

② When pointing value (PV) is not entered into wait use temperature range (ARIT ZONE) withing wait time.

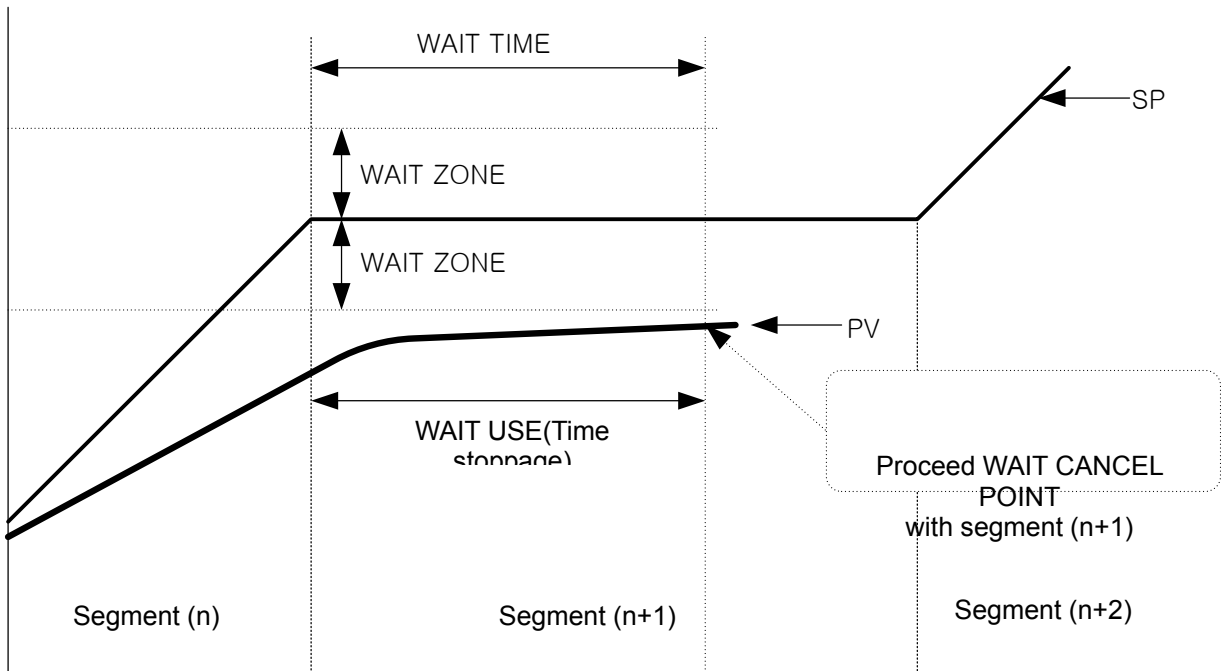

2.10.6 PATTERN NAME SETTING SCREEN

Figure 2-46. Pattern Name Setting Screen

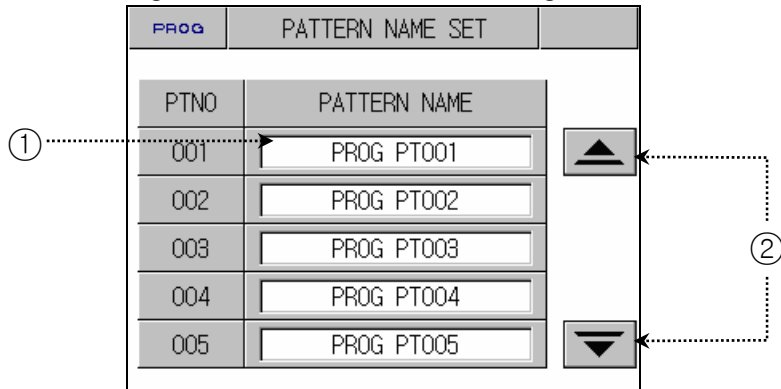

No.	Instruction	Contents	Additional Explanation
①	Pattern Name Button	Sets name for pattern.	▶ You can enter maximum of 10 letters.
②	Screen Shifting Button	Sets 120 pattern names using UP, DOWN button.	▶ Switch screens pattern unit of five.

2.10.6.1 HOW TO SET PATTERN NAME

- ▶ Setting method to enter pattern name, "TEST 8593W, in Pattern 3.

Figure 2-47. Before Setting Pattern Name

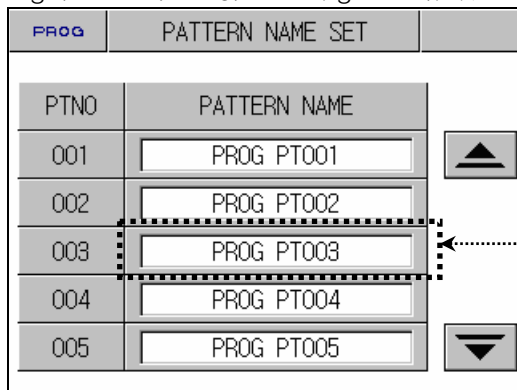
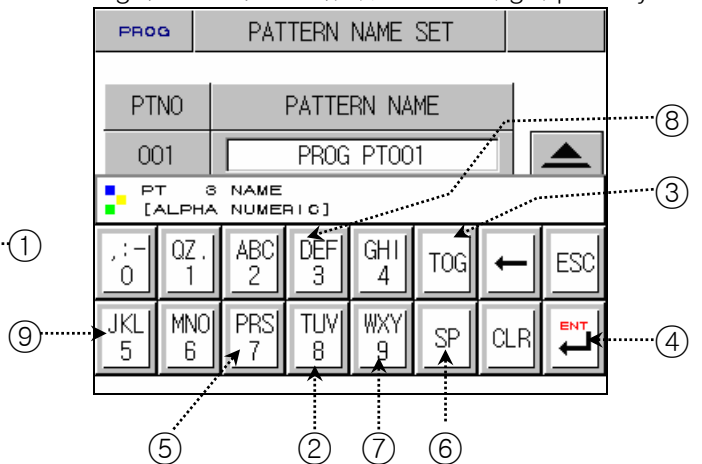

Figure 2-48. Pattern Name Setting Input Key



- 1) Figure2-48. Pattern Name Setting Input Key is displayed if you press anywhere of ① on the previous screen of Figure2-47. Pattern Name Setting will be displayed.
- 2) Setting the name of pattern which is wanted by pressing Button in order as ②→⑧→③→⑤→③→③→②→⑥→②→③→③→③→⑨→③→③→③→⑦→③→③→③→⑧→③→③→③→⑦→④ of the Figure 2-48. Pattern Name Setting Input Key.

2.11 DISPLAY SETTING

- ▶ Screen that adjusts light and activation of auto tuning.
- ▶ Screen that shows error history.

Figure 2-49. Display Setting

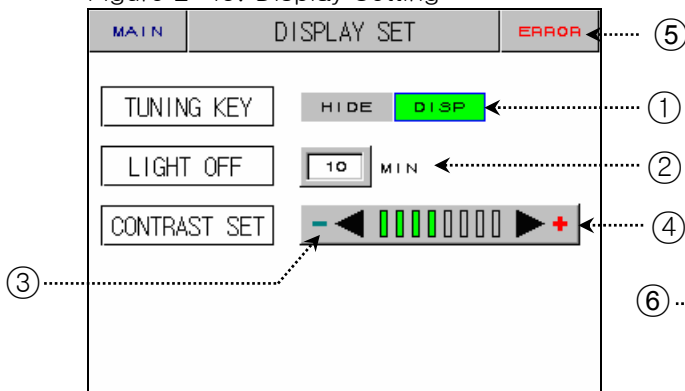
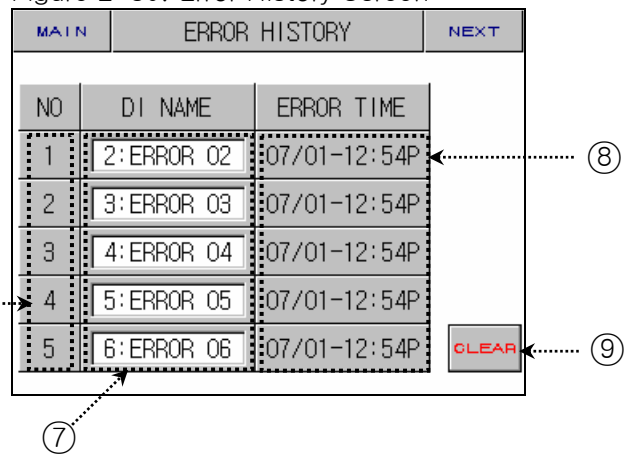

Figure 2-50. Error History Screen



No.	Instruction	Contents	Additional Explanation
①	Tuning Button	Activate tuning button of fix operation screen or hide it.	▶ Displays or hides tuning button in Figure2-20, Figure2-21.
②	Power Saving Time	Sets time for back light automatic turn off.	▶ Initially set 10 minutes for longing the back light life.
③	Light Increasing Button	Lightens screen.	▶ Screen light may change as a trait of STN LCD. For example, it looks darker in winter and lighter in summer. Adjust light using this button.
④	Light Decreasing Button	Darkens screen.	
⑤	Error History Button	Shifts to error history screen.	
⑥	Error Occurrence Order	Displays error occurrence order.	▶ It can display up to five. Error after the fifth one is stored at the end, and the first one is deleted.
⑦	Error Occurrence Name	Displays error occurrence name.	
⑧	Error Occurrence Time	Displays error occurrence time.	
⑨	Error History Delete	Delete all error history.	

2.12 SYSTEM SETUP

- ▶ Screen for initial setting for operation
- ▶ As it's possible to approach without a password in case of forwarding from factory, make sure of setting a password at 2.12.3 initialization mark and condition mark lamp Setting when it's not necessary to block the general user.
- ☞ **When it's changed in a wrong way, the Setting Points within the System Setting Screen can cause a problem in operating an equipment.**

Figure 2-51. System Setup Screen

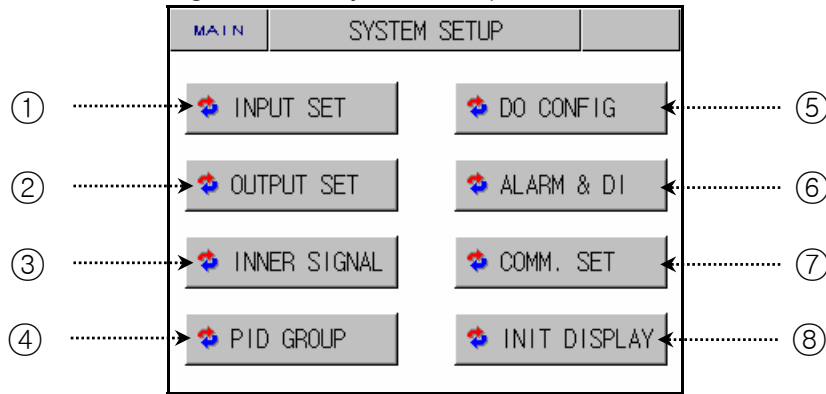

No.	Instruction	Contents	Additional Explanation
①	INPUT SET	Shifts to input and input compensation setting screen.	▶ Refer to 2.12.1 INPUT AND INPUT COMPENSATION SETTING
②	OUTPUT SET	Shifts to control output and transmission setting screen.	▶ Refer to 2.12.2 Control Output AND TRANSMISSION SETTING
③	INNER SIGNAL	Shifts to inner signal setting screen.	▶ Refer to 2.12.3 INNER SIGNAL SETTING
④	PID GROUP	Shifts to PID related setting screen.	▶ Refer to 2.12.4 PID SETTING
⑤	DO CONFIG	Shifts to additional output setting screen.	▶ Refer to 2.12.5 DO CONFIG SETTING
⑥	ALARM & DI	Shifts to alarm DI setting screen.	▶ Refer to 2.12.6 ALARM AND DI ERROR NAME SETTING
⑦	COMM. SET	Shifts to communication related setting screen.	▶ Refer to 2.12.7 COMMUNICATION SETTING
⑧	INIT DISPLAY	Shifts to initial screen related and condition display lamp setting screen.	▶ Refer to 2.12.8 INITIAL DISPLAY AND CONDITION DISPLAY LAMP SETTING

2.12.1 INPUT AND INPUT REVISION FOR SECTIONS

2.12.1.1 INPUT SENSOR SETTING

Figure 2-52. Input Sensor Setting – DCV

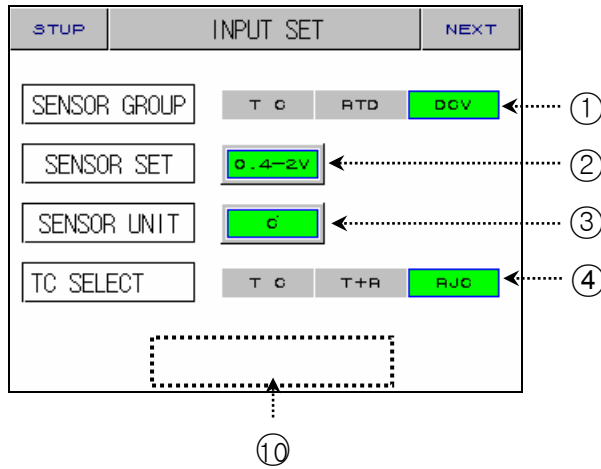
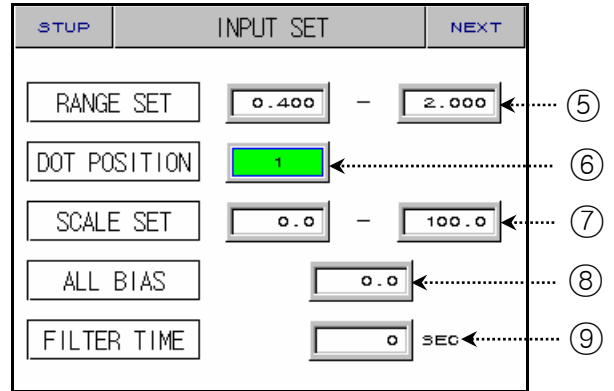

Figure 2-53. Input Sensor Setting– DCV



No.	Instruction	Contents	Additional Explanation
①	SENSOR GROUP	Chooses input sensor kind.	▶ You can choose T C, RTD, DCV.
②	SENSOR SET	Chooses input sensor.	
③	SENSOR UNIT	Chooses display unit.	▶ T C, RTD : °C, °F ▶ DCV : °C, °F, SPACE, %, Pa, mV, V, %RH, Ω
④	TC SELECT	Chooses RJC use when sensor input kind is TC.	▶ You can choose T C, T+R, RJC.
⑤	RANGE SET	Sets sensor usage range.	
⑥	DOT POSITION	Chooses below decimal point when sensor kind is “DCV.”	▶ Displays SENSOR GROUP = DCV
⑦	SCALE SET	Sets temperature usage range when sensor kind is “DCV.”	▶ Displays SENSOR GROUP = DCV
⑧	ALL BIAS	Sets the previous range revision value.	▶ Refer to <u>2.12.1.2 SECTION INPUT REVISION SETTING</u>
⑨	FILTER TIME	Removes noise when measuring input includes noise of high frequency.	
⑩	HIDDEN BUTTON	Shifts section input revision setting.	▶ Displays <u>2.13 PASSWORD INPUT</u> screen. ▶ Refer to <u>2.12.1.2 SECTION INPUT REVISION SETTING</u>

☞ cannot change sensor kind during operation.

☞ Displays “S.OPN” when sensor is disconnected. Displays PRESET OUTPUT for Control Output (MV).



Kinds of Sensor Input

No	SENSOR SET	Temperature Range (°C)	Temperature Range (°F)	SENSOR GROUP	DISP
1	K1	-200.0~1370.0	-300.0~2500.0	T/C	TC-K1
2	K2	-200.0~1000.0	0.0~2300.0		TC-K2
3	J	-200.0~1200.0	-300.0~2300.0		TC-J
4	E	-200.0~1000.0	-300.0~1800.0		TC-E
5	T	-200.0~400.0	-300.0~750.0		TC-T
6	R	0.0~1700.0	32~3100		TC-R
7	B	0.0~1800.0	32~3300		TC-B
8	S	0.0~1700.0	32~3100		TC-S
9	L	-200.0~900.0	-300.0~1600.0		TC-L
10	N	-200.0~1300.0	-300.0~2400.0		TC-N
11	U	-200.0~400.0	-300.0~750.0		TC-U
12	W	0.0~2300.0	32~4200.0		TC-W
13	Platine II	0.0~1390.0	-32.0~2500.0		TC-P
14	PTA	-200.0~850.0	-300.0~1560.0	RTD	PTA
15	PTB	-200.0~500.0	-300.0~1000.0		PTB
16	PTC	-50.00~150.00	-148.0~300.0		PTC
17	JPTA	-200.0~500.0	-300.0~1000.0		JPTA
18	JPTB	-50.00~150.00	-148.0~300.0		JPTB
19	0.4~2.0V	0.400~2.000V		DCV	0.4-2V
20	1~5V	1.000~5.000V			1-5V
21	0~10V	0.00~10.00V			0-10V
22	-10~20mV	-10.00~20.00mV			-10-20
23	0~100mV	0.0~100.0mV			0-100

☞ Display : -5% ~ +105% of the above range



Engineering Units – EU, EUS

- ▶ EU, EUS are used to explain the interior parameter of controller.
- ☞ EU() : Engineering unit value according to instrument range.
- ☞ EUS() : Engineering range according to instrument span.

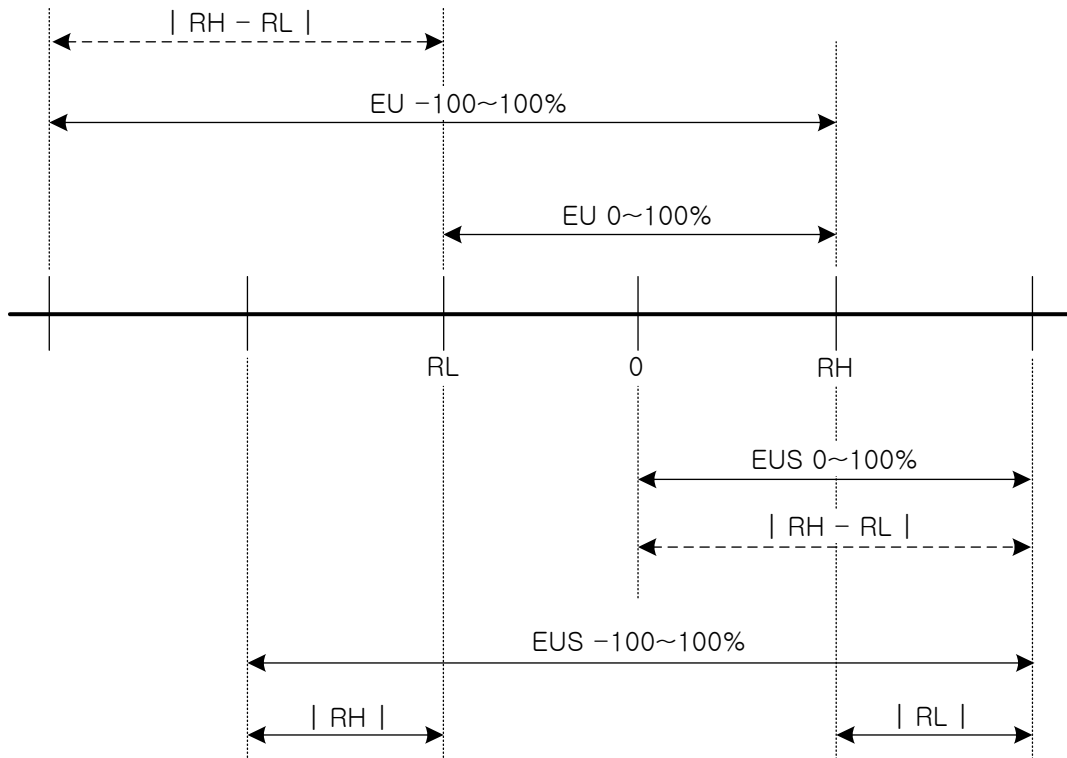

▶ Range of EU(), EUS()

	RANGE	CENTER POINT
EU 0 ~ 100%	RL ~ RH	$ RH - RL / 2 + RL$
EU -100 ~ 100%	$-(RH - RL + RL) \sim RH$	RL
EUS 0 ~ 100%	$0 \sim RH - RL $	$ RH - RL / 2$
EUS -100 ~ 100%	$- RH - RL \sim RH - RL $	0

- ▶ INPUT = T C(TC-K1)
- ▶ RANGE = -200.0°C(RL) ~ 1370.0°C(RH)

	RANGE	CENTER POINT
EU 0 ~ 100%	- 200.0 ~ 1370.0°C	585.0°C
EU -100 ~ 100%	- 1770.0 ~ 1370.0°C	- 200.0°C
EUS 0 ~ 100%	0 ~ 1570.0°C	785.0°C
EUS -100 ~ 100%	- 1570.0 ~ 1570.0°C	0.0°C

☞ ABS doesn't change along input of absolute value.

2.12.1.2 SECTION INPUT REVISION SETTING

- ▶ Section revision is applied as a form of linear equation between each revision points.

Figure 2-54. Section Input Revision Setting

STUP	SENSOR PEACE BIAS			
	POINT 1	POINT 2	POINT 3	POINT 4
DDV	0.0	0.0	0.0	0.0
DPV	-50.0	150.0	150.0	150.0
	POINT 5	POINT 6	POINT 7	POINT 8
DDV	0.0	0.0	0.0	0.0
DPV	150.0	150.0	150.0	150.0
③	NOW PV	S.OPN	c	

No.	Instruction	Contents	Additional Explanation
①	DRY TEMP DIFFERENCE VALUE	Sets revision temperature at each standard temperature.	
②	DRY TEMP REFERENCE POINT	Sets each standard temperature.	
③	BIASED DRY TEMP PV	Display temperature input revision is applied.	



Section Input Revision Setting

- ▶ Indicates section input revision at the temperature
- ▶ S.PV = Actual SensorTemperature, B.PV = Temperature after the revision, RL = Below input, RH = Above input
- ▶ Pn(P) = Standard Temperature, Pn(D) = Revision Temperature
(POINT n.DPV= P n(P), POINT n.DDV= Pn(D))
(n = 1, 2, 3, 4, 5, 6, 7, 8)

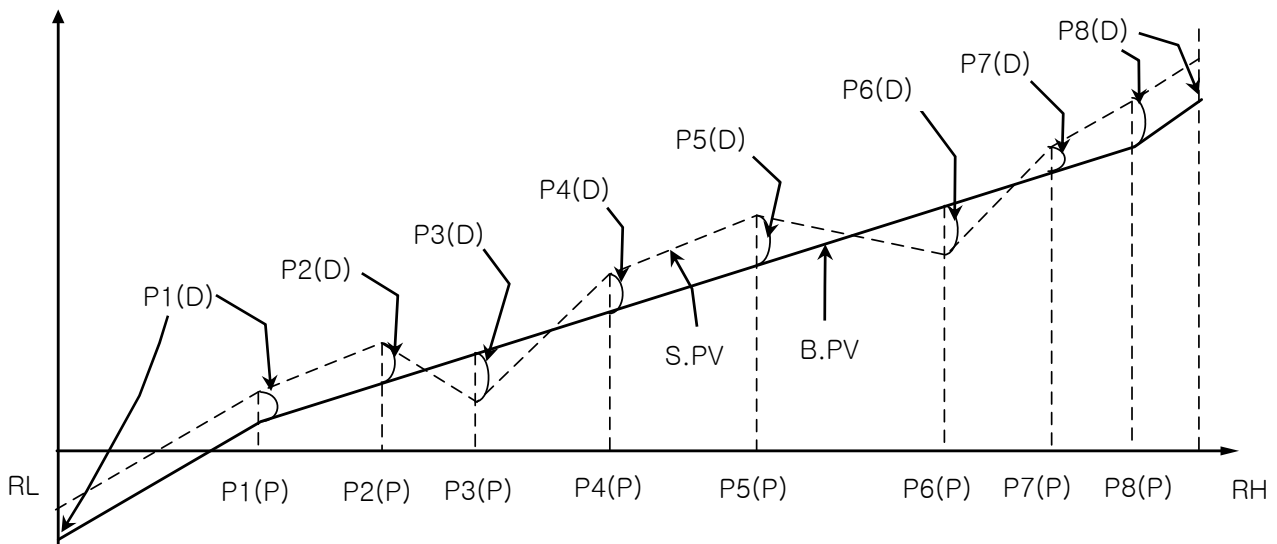

- ▶ B.PV at RL ~ POINT1

$$= S.PV + P1(D)$$

- ▶ B.PV at POINT1 ~ POINT2

$$= S.PV + (S.PV - P1(P)) \times \frac{ (P2(D) - P1(D)) }{ (P2(P) - P1(P)) } + P1(D)$$

⋮

- ▶ B.PV at POINT7 ~ POINT8

$$= S.PV + (S.PV - P7(P)) \times \frac{ (P8(D) - P7(D)) }{ (P8(P) - P7(P)) } + P7(D)$$

- ▶ B.PV at POINT8 ~ RH

$$= S.PV + P8(D)$$

2.12.2 CONTROL OUTPUT AND TRANSMISSION SETTING SCREEN

2.12.2.1 CONTROL OUTPUT SETTING

Figure 2-55. Temperature (heat) Control Output Setting

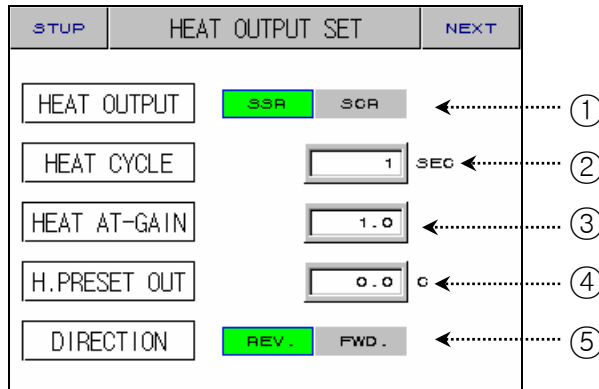
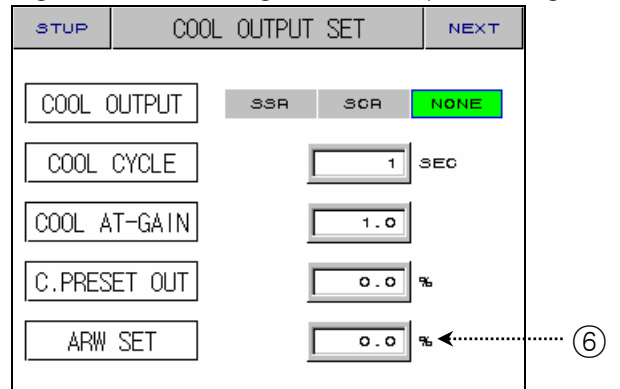

Figure 2-56. Cooling Control Output Setting



No.	Instruction	Contents	Additional Explanation
①	OUTPUT	Sets a kind of control output.	▶ COOL OUTPUT : heat/ cool control NONE: general control, display 0.0% for cool output
②	CYCLE	Sets output cycle when Control Output is " SSR (Solid State Relay) "	▶ Controls sensitively if output cycle is short.
③	AT GAIN	Adjusts PID manually according to the characteristic of system after auto tuning.	▶ Control Output = PID X GAIN
④	PRESET OUT	Cuts PID output from STOP, S.OPN, ERROR occurring and displays PRESET OUT	▶ General Control: H.PRESET OUT ▶ heat/cool : H.PRESET OUT : C.PRESET OUT
⑤	DIRECTION	Sets right and reverse motion of PID control.	
⑥	ANTI RESET WIND-UP	Prevents excessive integral at setting point.	



Right And Reverse Motion

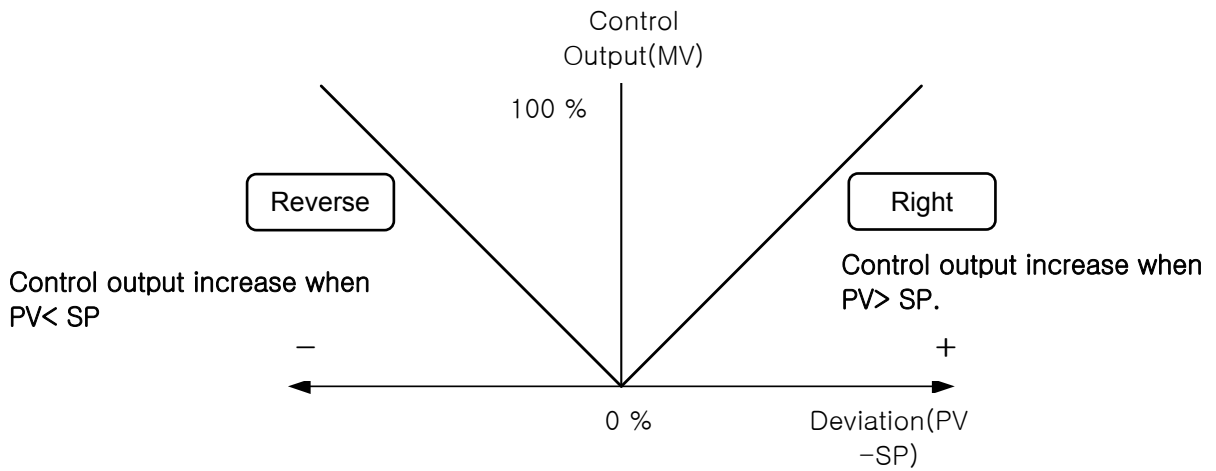

CYCLE TIME

- ▶ Applies only when a kind of control output is "SSR(Solid State Relay)"
- ▶ Indicates on/off time of one cycle.
- ▶ where output cycle is 10 sec.

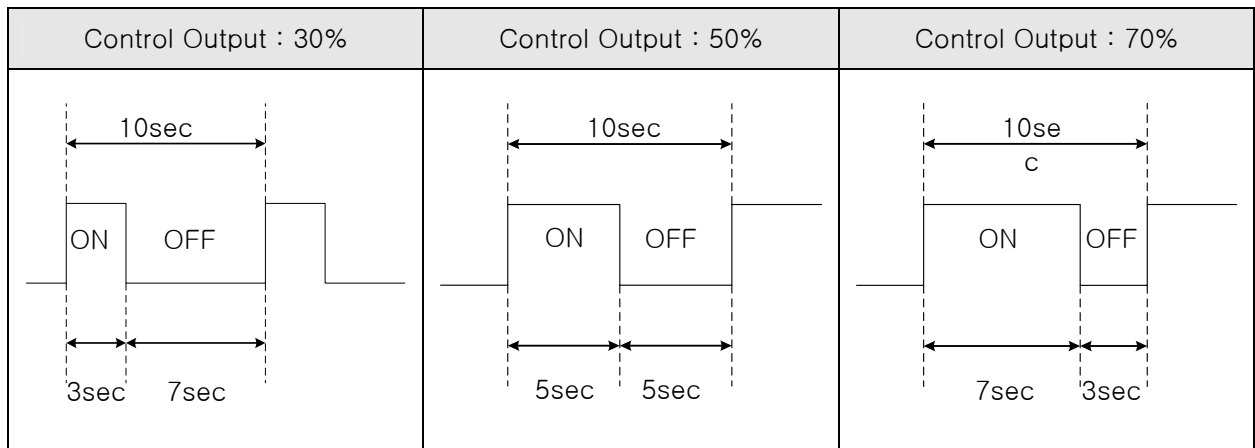



AT GAIN(AUTO TUNING GAIN)

▶ AT GAIN is used to change the control characteristics based on PID value after auto tuning.

👁 **Use calculated setting point after auto tuning**

▶ You can adjust AT GAIN based on targets and characterists.

① AT GAIN < 1.0

→ Response time is fast, but hunting is severe.

② AT GAIN > 1.0

→ Overshoot is lessened, but response time is slow..

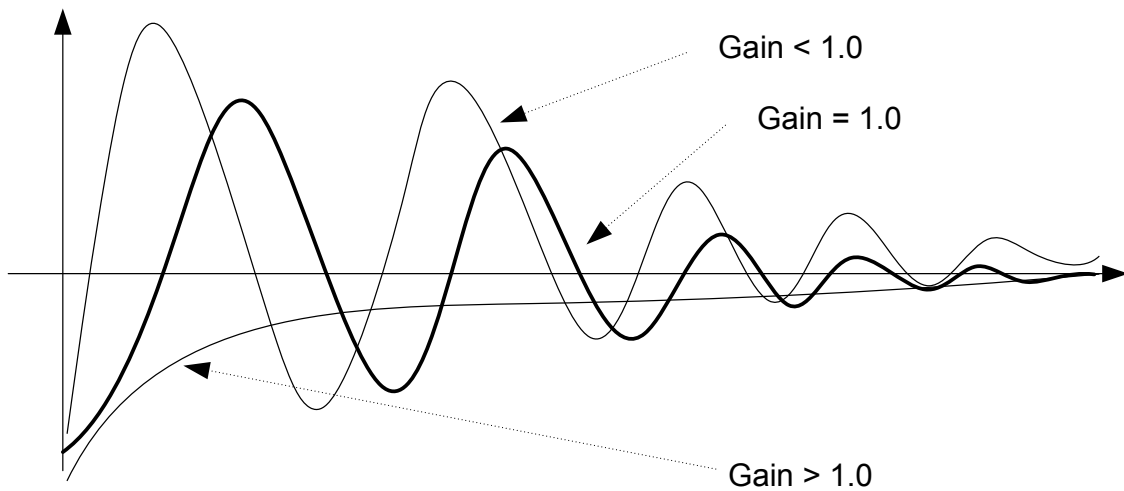



Anti Reset Wind Up

NOTE

- ▶ One of methods to control during disturbance.
- ▶ Doesn't operate when PID Setting Point is I=0.
- ▶ Control Output(MV) at PID control
 $MV = P(\text{Proportional value}) + I(\text{Integral value}) + D(\text{Differential value})$

when there is no possibility of the prevention of Anti Reset Wind up

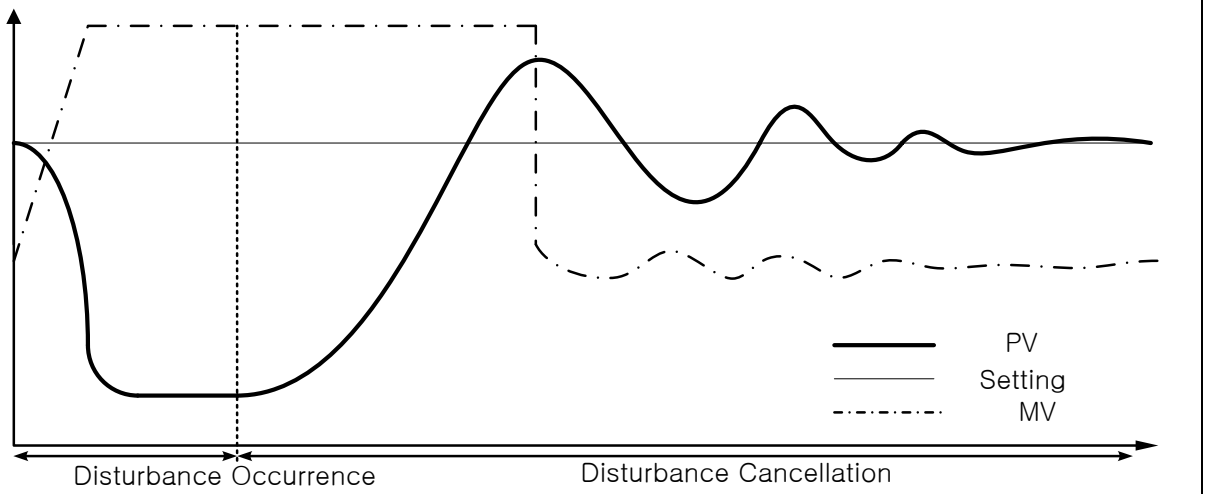

When disturbance occurs, Control Output(MV) rises to fit with setting point(SP) and pointing value(PV) drops.
 If such disturbance sustains for a long time, it takes long time for disturbance to be cancelled due to accumulation of intgral value. Overshoot is large as Figure above and it takes time for pointing value (PV) to be stabilized.

when there is a possibility of the prevention of Anti Reset Wind up

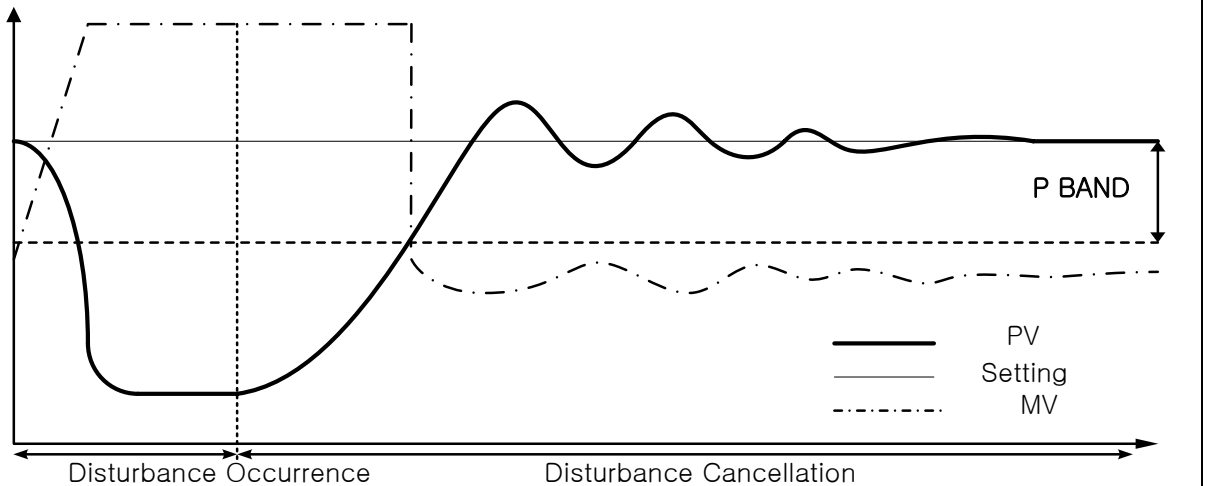

From the point where pointing value (PV) enters into **P BAND**, overshoot is small and PV is stabilized fast because accumulation of the integral value is solved.

▶ Example of how to set **P BAND**

→ Sensor Input:0.0~100.0℃ , Current Operation PID No. : 1 , P of PID1 group:10.0% , ARW : 200%

$$\begin{aligned}
 \text{P BAND} &= 200\% \text{ of P} \\
 &= 20.0\%(P*2) \\
 &= 20.0^\circ\text{C}(\text{total input}*0.2)
 \end{aligned}$$

☞ **MV starts changing from |PV-SP|= P BAND point**

Ex)Setting Point(SP): Control Output(MV) starts changing from PV:50.0℃ if PV is 70.0℃.

→ Since |PV-SP|= P BAND, |50.0 -70.0|=20.0

2.12.2.2 TRANSMISSION OUPUT SET

Figure 2-57. Transmission Output Setting

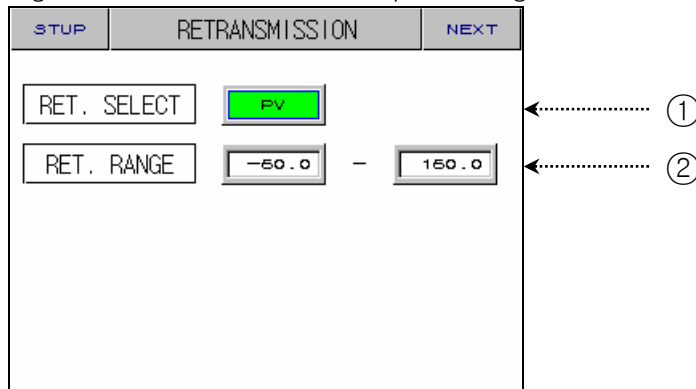

No.	Instruction	Contents	Additional Explanation
①	RET. SLELCT	Chooses transmission kind.	
②	RET. RANGE	Sets the range of transmission.	▶ If temperature transmission kind is "MV", it's not displayed.

☞ Transmission output is displayed as 4~20mA. If you want to use transmission output as 1~5V, Please use it after attaching 250Ω RN-TYPE resistance (precision resistance) at the Transmission output terminal.

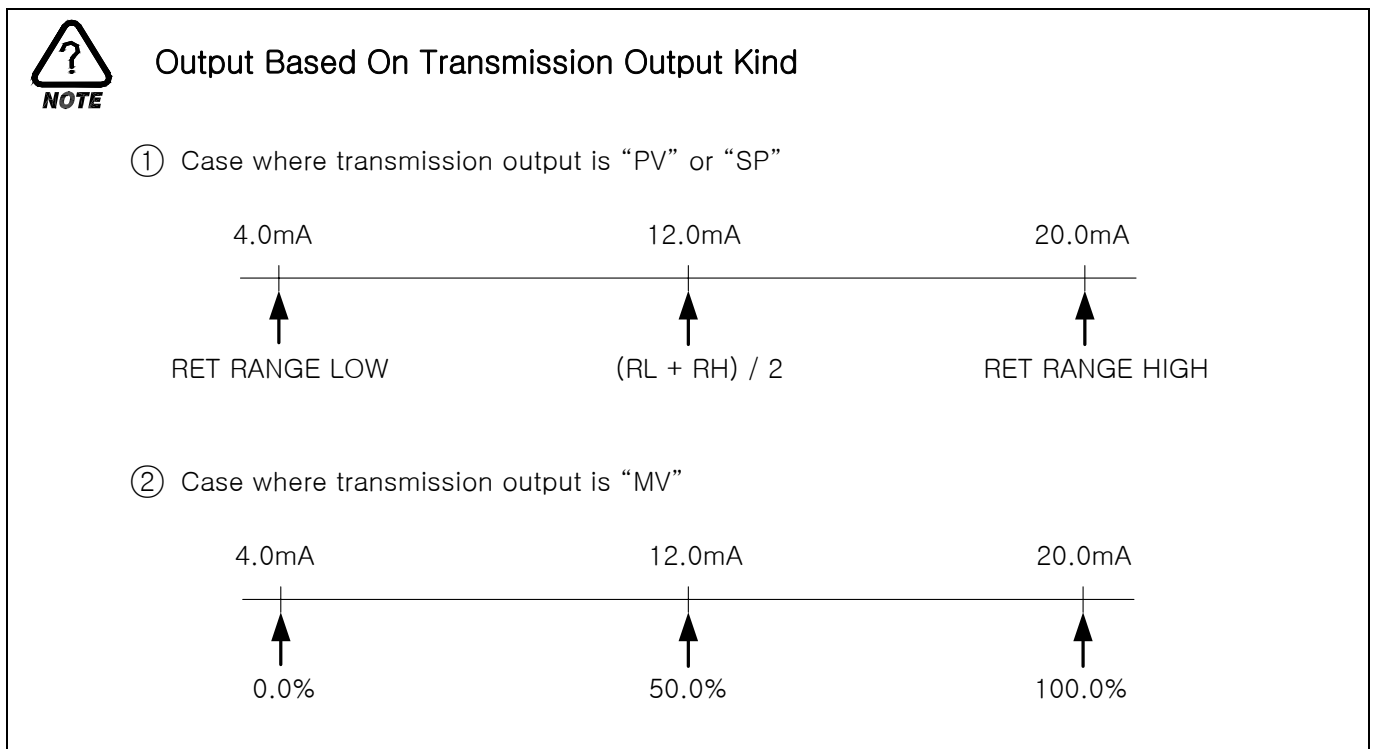

2.12.3 INNER SIGNAL SETTING SCREEN

► Can set eight inner signals.

Figure 2-58. Inner Signal Setting Screen

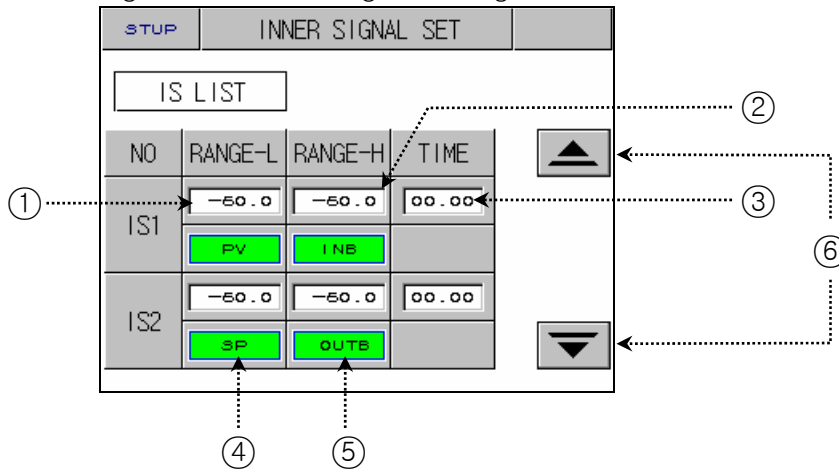

No.	Instruction	Contents	Additional Explanation
①	RANGE LOW	Sets minimum value of Inner Signal.	
②	RANGE HIGH	Sets maximum value of Inner Signal.	
③	DELAY TIME	Sets delay time of Inner Signal.	► Related to 1REF, 2REF output time of 2.12.5 DO CONFIG Setting
④	TYPE BUTTON	Selects Inner Signal kind to use.	► SP : Present Setting Point ► PV : Present pointing value ☞ It has hysteresis of EUS 0.5% (impossible to change) when selected to PV). ► TSP : Target setting point during program control.
⑤	BAND BUTTON	Selects direction of Inner Signal.	
⑥	Screen Move Button	Sets eight inner signals using UP, DOWN button.	► Switches screen to two Inner Signal units.

☞ If slope for fix operation is set, "TSP" operates as "TSP" of program control. But if slope is not set, "TSP" operates as "SP".

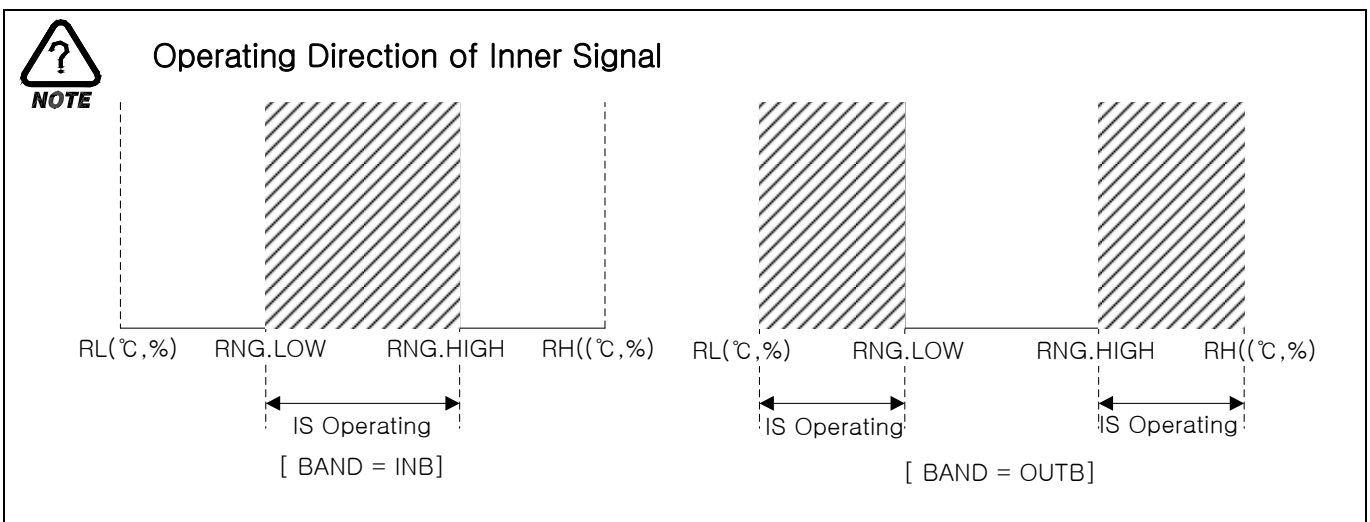



Example of Inner Signal Operation

▶ Inner Signal Operation According To Setting Point

Setting	Inner Signal Move
<ul style="list-style-type: none"> ▶ INPUT = 0.0 ~ 100.0 → EUS 0.5% = 0.5 ▶ OPER. MODE = PROG ▶ TYPE = PV ▶ RANGE LOW = 30.0°C ▶ RANGE HIGH = 50.0°C ▶ DIRECT = IN BAND ▶ DELAY TIME = 00.00 	
<ul style="list-style-type: none"> ▶ INPUT = 0.0 ~ 100.0 → EUS 0.5% = 0.5 ▶ OPER. MODE = PROG ▶ TYPE = PV ▶ RANGE LOW = 30.0°C ▶ RANGE HIGH = 50.0°C ▶ DIRECT = OUT BAND ▶ DELAY TIME = 00.00 	
<ul style="list-style-type: none"> ▶ INPUT = 0.0 ~ 100.0 ▶ OPER. MODE = PROG ▶ TYPE = SP ▶ RANGE LOW = 30.0°C ▶ RANGE HIGH = 50.0°C ▶ DIRECT = IN BAND ▶ DELAY TIME = 00.10 	
<ul style="list-style-type: none"> ▶ INPUT = 0.0 ~ 100.0 ▶ OPER. MODE = PROG ▶ TYPE = TSP ▶ RANGE LOW = 30.0°C ▶ RANGE HIGH = 50.0°C ▶ DIRECT = OUT BAND ▶ DELAY TIME = 00.00 	

2.12.4 PID SET SCREEN

2.12.4.1 PID RANGE SET

- Consists of 3 Temperature PID and 1 deviation PID.

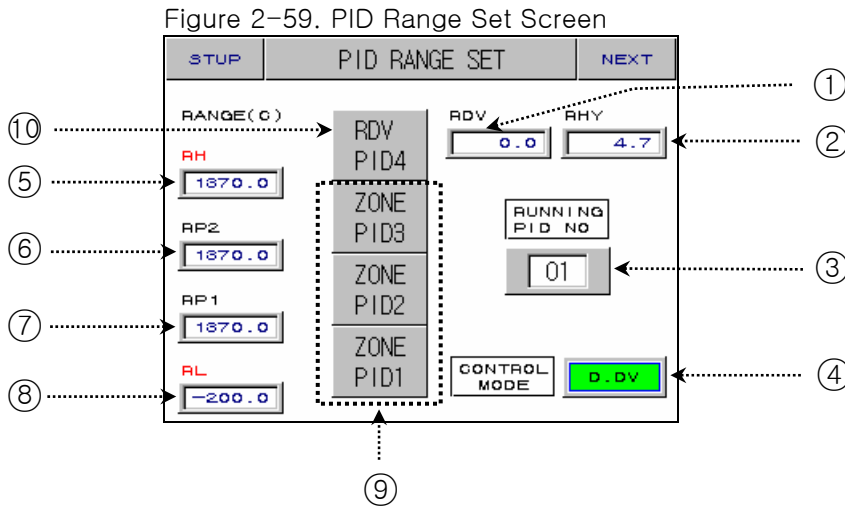

No.	Instruction	Contents	Additional Explanation
①	REFERENCE DEVIATION	Sets deviation for selecting deviation PID.	
②	REFERENCE HYSTERESIS	Selects hysteresis width when selecting PID group at Zone PID.	
③	RUNNING PID NUMBER	Displays operating PID number.	
④	CONTROL MODE	Sets D.DV or D.PV as operation mode when controls PID. W	
⑤	TEMP RANGE HIGH	High limit of temperature.	► It changes as TEMP.RH(TEMP RANGE HIGH) setting point of <u>2.12.1.1 Temperature Input Setting</u> changes. ✎ Cannot amend.
⑥	REFERENCE POINT2	Sets limit value which selects ZONE PID for temperature SPAN.	► $RL \leq RP1 \leq RP2 \leq RH$
⑦	REFERENCE POINT1		
⑧	TEMP RANGE LOW.	Low limit of temperature.	► It changes as TEMP.RL (TEMP RANGE LOW) setting point of <u>2.12.1.1 Temperature Input Setting</u> changes. ✎ Cannot amend.
⑨	ZONE PID	Temperature PID group.	► Shifts to the setting screen of target PID group if you press number.
⑩	RDV PID	Deviation PID	



PID Group And Control Mode

ZONE PID(PID1~3)	Contents
	<p>▶ PID group is set by pointing value (PV). Therefore, PID group may change continuously if pointing value shakes near RP1 or RP2.</p> <p>To prevent the frequent shake or PID group, set hysteresis (RHY).</p>
Deviation PID(PID4)	Contents
	<p>▶ Deviation PID can be used when setting RDV (deviation setting point). Controls deviation PID when pointing value minus setting point is bigger deviation setting point (RDV).</p>
D.DV Control	Contents
	<p>▶ During D.DV control, since changing rate of output (MV) is small, overshoot is little and time to target setting point (TSP) is delayed a little bit.</p> <p>▶ Suitable for a device which responds sensitively upon output (MV) changing rate.</p>
D.PV Control	Contents
	<p>▶ During D.DV control, since changing rate of output (MV) is large, overshoot happens and time to target setting point (TSP) is faster than D.DV control time.</p> <p>▶ Suitable for a device which responds slowly upon output (MV) changing rate.)</p>



Auto Tuning and Tuning Point

- ▶ Auto Tuning is a function which controller automatically measures and calculates its characteristics, and sets an optimal PID number automatically.
- ▶ Auto Tuning makes ON/OFF Control Output for 2.5 cycling time, and calculate P.I.D by the cycle and amplitude by using Limit Cycle method to target subject to control.
- ▶ AutoTuning only operates for fix operation. It automatically sets calculated P,I,D value at PID group where setting point is located.

▶ Auto Tuning Operation According to Setting Point

Setting

- ▶ OPER. MODE = FIX RUN
- ▶ INPUT = RTD(PTC)
- ▶ RANGE = $-50.00^{\circ}\text{C} \sim 150.00^{\circ}\text{C}$
- ▶ AUTO TUNING POINT = 0.25%(fixed)
→ EUS 0.25% = 0.5°C
- ▶ SP = 50.0°C
- ▶ OL = 0.0%
- ▶ OH = 100.0%

Auto Tuning Operation

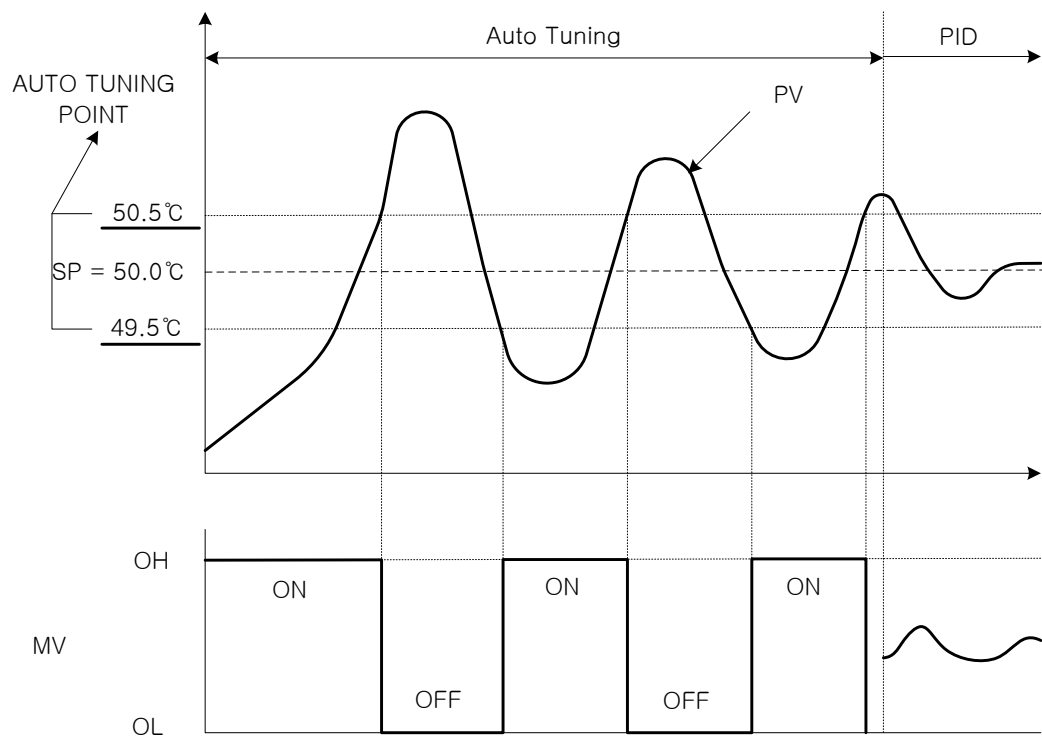

▶ Caution for AutoTuning

- Even if setting point is changed during Auto Tuning, Tuning Point does not change. And it starts controlling using new setting point after Auto Tuning Stop as target setting point.
- Auto Tuning stops if input S.OPN occurs during Auto Tuning. P, I, D maintains the previous setting point.
- P, I, D setting point may be changed during Auto Tuning, but will be reset to calculated P, I, D at the time of Auto Tuning Stop.
- If Auto Tuning is forced to stop, P, I, D value maintains setting point before Auto Tuning Stop.

2.12.4.2 PID GROUP (PID1~PID4) SETTING

► Generally, it uses value calculated by Auto Tuning, but users can set manually as well.

Figure 2-60. PID Group (general)

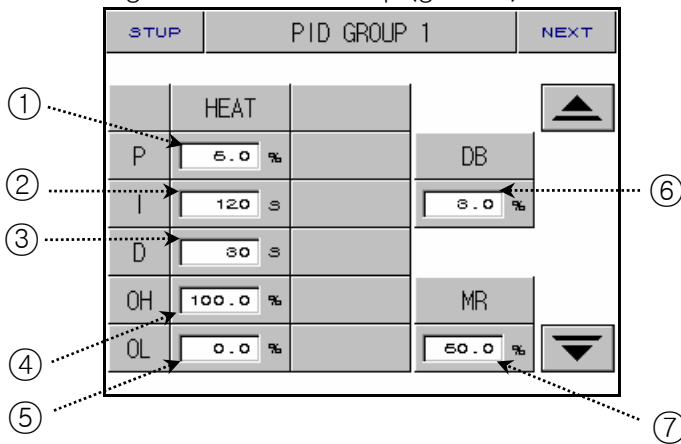
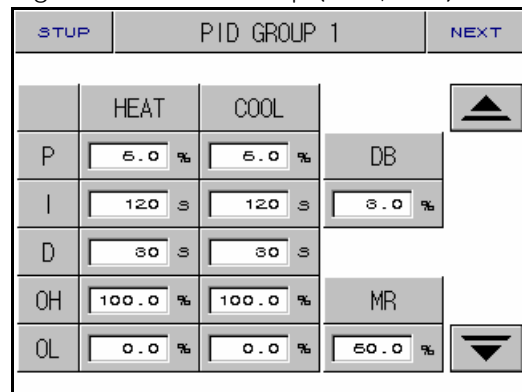

Figure 2-61. PID Group (heat/cool)



No.	Instruction	Contents	Additional Explanation
①	PROPORTIONAL BAND	Sets proportional band.	<ul style="list-style-type: none"> ► Lessens the different between setting point(SP) and the pointing value (PV). ☞ Large proportional band: PV approaches to SP quickly, but vibration of MV will affect adversely upon safety of control. Small proportional band: PV approaches to SP slowly, and remaining deviation may occur.
②	INTEGRAL TIME	Sets integral time.	<ul style="list-style-type: none"> ► Expanding integral time: Control Output(MV) is lessened. Therefore, approaching time to setting point(SP) is lengthened. Shortening integral time: Control Output(MV) is increased. Therefore, approaching time to setting point is shortened. ☞ Intergal operation can eliminate remaining derivitation at program operation. ☞ If integral time is too short, controlling may become impossible.
③	DERIVATIVE TIME	Sets derivative time.	<ul style="list-style-type: none"> ► It restrains PV-SP changing rate by caculating MV which rises along PV-SP changing rate. ☞ It restrains a radical change of PV or disturbance and accerates the approach to setting point(SP).

④	OUTPUT LIMIT HIGH	Sets control output operation range limit high.	▶ OH > OL
⑤	OUTPUT LIMIT LOW	Sets control output operation range limit low.	
⑥	DEAD BAND	Parameter to set Dead Band of heat/cool run.	
⑦	MANUAL RESET	Parameter to apply manually integral time of PID if integral time(I) is '0' at PID control.	

2.12.5 DO CONFIG SETTING SCREEN

▶ Setting relay which displays operation signal through I/O relay board.

Figure 2-62. DO CONFIG Setting – 1Screen

STUP		DO CONFIGURATION		NEXT	
IS LIST					
DO	RELAY	DO	RELAY		
IS1	<input type="checkbox"/>	IS5	<input type="checkbox"/>		
IS2	<input type="checkbox"/>	IS6	<input type="checkbox"/>		
IS3	<input type="checkbox"/>	IS7	<input type="checkbox"/>		
IS4	<input type="checkbox"/>	IS8	<input type="checkbox"/>		

Figure 2-63. DO CONFIG Setting – 2Screen

STUP		DO CONFIGURATION		NEXT	
TS/AL LIST					
DO	RELAY	DO	RELAY		
TS1	<input type="checkbox"/>	AL1	<input type="checkbox"/>		
TS2	<input type="checkbox"/>	AL2	<input type="checkbox"/>		
TS3	<input type="checkbox"/>	AL3	<input type="checkbox"/>		
TS4	<input type="checkbox"/>	AL4	<input type="checkbox"/>		

Figure 2-64. DO CONFIG Setting – 3Screen

STUP		DO CONFIGURATION		NEXT	
OTHER LIST					
DO	RELAY	CPARA			
RUN	<input type="checkbox"/>	<input type="text"/> SEC			
UP	<input type="checkbox"/>	<input type="text"/> C			
SOAK	<input type="checkbox"/>	<input type="text"/> MIN			
DOWN	<input type="checkbox"/>	<input type="text"/> C			

Figure 2-65. DO CONFIG Setting – 4Screen

STUP		DO CONFIGURATION		NEXT	
OTHER LIST					
DO	RELAY	CPARA			
ERROR	<input type="checkbox"/>	<input type="text"/> MIN			
PTEND	<input type="checkbox"/>	<input type="text"/> MIN			
1REF	<input type="checkbox"/>	<input type="text"/> SEC			
2REF	<input type="checkbox"/>	<input type="text"/> MIN			

No.	Instruction	Contents	Additional Explanation
①	INNER SIGNAL	Sets relay number to display Inner Signal.	▶ Refer to 2.12.3 Inner Signal Setting
②	TIME SIGNAL	Sets relay number to display Time Signal.	▶ Refer to 2.10.4 Time Signal Setting
③	ALARM SIGNAL	Sets relay number to display Alarm Signal.	▶ Refer to 2.12.6 Alarm and DI ERROR Name Setting
④	RUN SIGNAL	Sets relay number to display Operation (Run) Signal.	▶ Displays during fix operation (run) or program operation. ▶ Relay is turned on after time you set.

⑤	UP SIGNAL	Sets relay number to display Up Signal.	<ul style="list-style-type: none"> ▶ FIX RUN → It can be established and operated up to (- EUS 10% ~ EUS 10%). ▶ PROG RUN → Relay is turned on for [Target Setting Point(TSP) - Setting Temperature] → Although it can be established up to (- EUS 10% ~ EUS 10%), it can be operated within the sector of (0 ~ EUS 10%). <p>☞ Status lamp and relay of Operation Screen operate together.</p>
⑥	DOWN SIGNAL	Sets relay number to display Down Signal.	
⑦	SOAK SIGNAL	Sets relay number to display soak signal.	<ul style="list-style-type: none"> ▶ During fix operation, status lamp is displayed, but no relay. ▶ During Program Operation, status lamp and relay are turned on for [SOAK TIME) - Setting Time]
⑧	ERROR SIGNAL	Sets relay number to display signal when error occurs.	▶ Relay is turned on for time you set when error of D12~D18 occurs.
⑨	PATTERN END SIGNAL	Sets relay number to output Program Operation End signal.	▶ Relay is turned on as long as time is set when program operation ends.
⑩	1st REF. SIGNAL	Sets relay number to output signal for the 1 st cooler operation.	▶ Relay is turned on after seconds that you set after Inner Signal1(IS1) is displayed.
⑪	2nd REF. SIGNAL	Sets relay number to output signal for the 2nd cooler operation.	▶ Relay is turned on after minutes that you set after Inner Signal1(IS1) is displayed.

☞ **Case where relay numbers are overlapped: If any signal is displayed, relay operates ("OR" condition).**



UP, SOAK, DOWN SIGNAL

NOTE

- ▶ INPUT = TEMP(PT_1), RANGE = -50.00℃ ~ 150.00℃
- ▶ UP, DOWN SIGNAL RANGE → [EUS 0% ~ EUS 10%] = [0.00 ℃ ~ 20.00 ℃]

Setting	UP, SOAK, DOWN RELAY MOTION According to Setting Point
<ul style="list-style-type: none"> ▶ OPER. MODE → PROG RUN ▶ TEMP UP → 0.2 ℃ ▶ TEMP SOAK → 2 MIN ▶ TEMP DOWN → 0.2 ℃ 	<p style="text-align: center;">TEMP SOAK RELAY OUT</p> <p style="text-align: center;">TEMP DOWN RELAY OUT</p>
<ul style="list-style-type: none"> ▶ OPER. MODE → FIX RUN ▶ TEMP UP → 0.2 ℃ ▶ TEMP SOAK → 2 MIN ▶ TEMP DOWN → 0.2 ℃ <p>☞ For SOAK signal, During fix operation, only status lamp for operation screen is turned on during fix operation (no relay is turned on).</p>	<p style="text-align: center;">TEMP UP RELAY OUT</p> <p style="text-align: center;">TEMP SOAK LAMP OUT</p> <p style="text-align: center;">TEMP DOWN RELAY OUT</p>

2.12.6 ALARM AND DI ERROR NAME SETTING

2.12.6.1 ALARM SETTING

Figure 2-66. Alarm Setting Screen

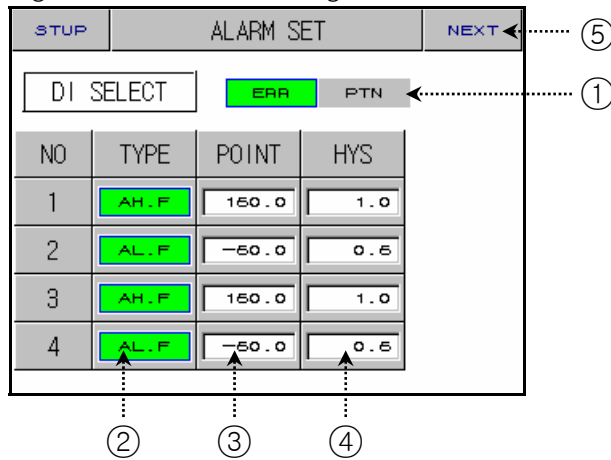

No.	Instruction	Contents	Additional Explanation			
①	DI SELECT	Selects a kind for error.	☞ Refer to <u>PAGE77 Error Operation</u>			
②	ALARM TYPE SELECT	Selects a kind for alarm.	Display	Alarm Types	Direction	Wait Operation
			AH.F	Upper limit of PV	Right	Nothing
			AL.F	Lower limit of PV	Right	Nothing
			DH.F	Upper limit of deviation	Right	Nothing
			DL.F	Lower limit of deviation	Right	Nothing
			DH.R	Upper limit of deviation	Reverse	Nothing
			DL.R	Lower limit of deviation	Reverse	Nothing
			DO.F	Out of the range of upper and lower limit of deviation	Reverse	Nothing
			DI.F	Within the range of upper and lower limit deviation	Reverse	Nothing
			AH.R	Upper limit of PV	Reverse	Nothing
			AL.R	Lower limit of PV	Reverse	Nothing
			AH.FS	Upper limit of PV	Right	Existent
			AL.FS	Lower limit of PV	Right	Existent
			DH.FS	Upper limit of deviation	Right	Existent
			DL.FS	Lower limit of deviation	Right	Existent
			DH.FS	Upper limit of deviation	Reverse	Existent
			DL.RS	Lower limit of deviation	Reverse	Existent
			DO.FS	Out of the range of upper and lower limit of deviation	Right	Existent
DI.FS	Within the range of upper and lower limit deviation	Right	Existent			
AH.RS	High Limit Pointing Value	Reverse	Existent			
AL.RS	Low Limit Pointing Value	Reverse	Existent			

③	ALARM POINT	Sets alarm value.	
④	ALARM HYSTERESIS	Sets hysteresis for alarm operation.	
⑤	NEXT BUTTON	Shifts to DI Error Name Setting Screen.	▶ Refer to 2.12.5.2 DI Error Name Setting

☞ Alarm Operation also runs during operation stop status.

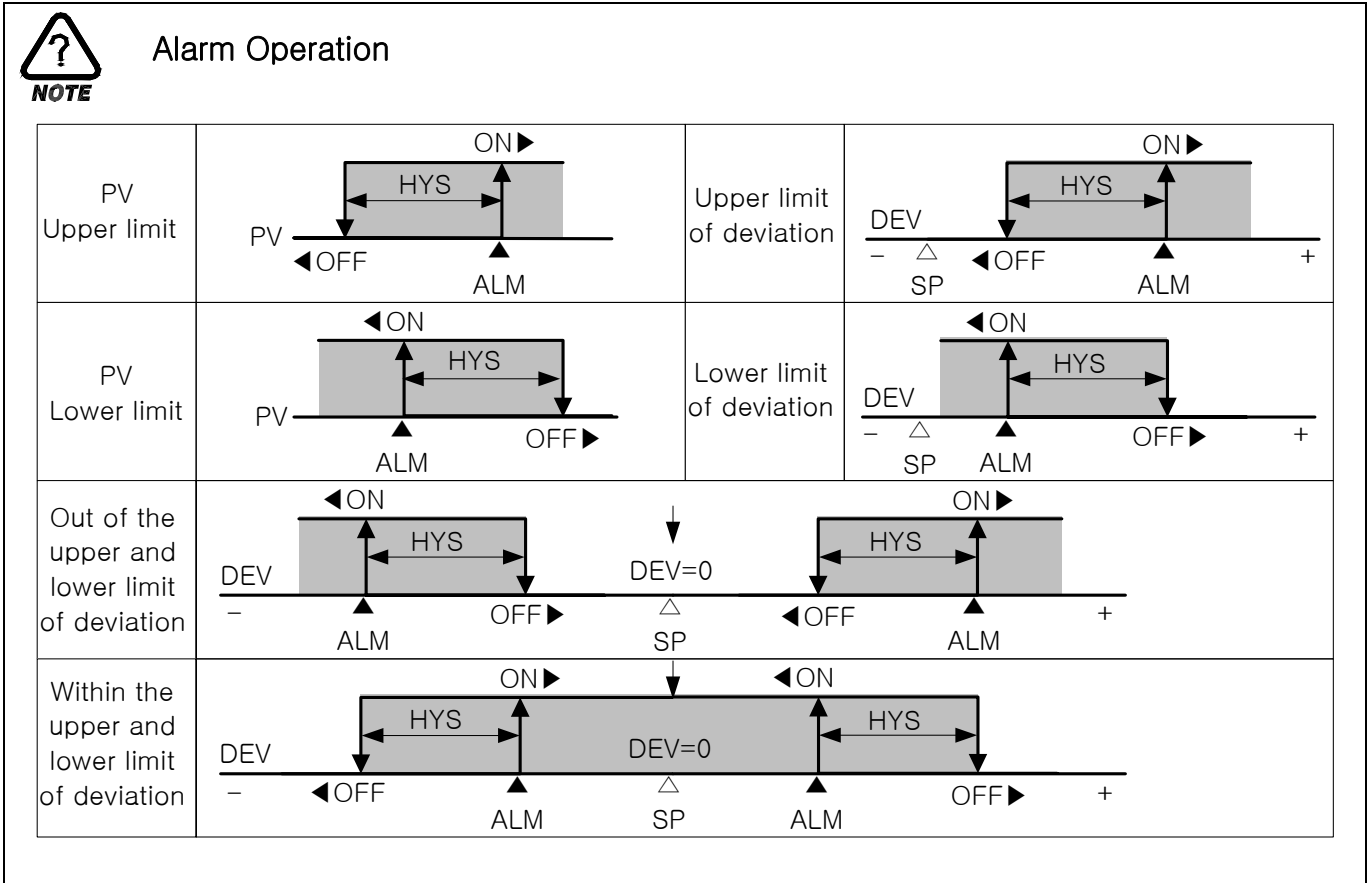



Error Operation

DI SELECT	DI1	DI2	DI3	DI4	DI5	DI6	DI7	DI8	Operation
ERR	ON	OFF	OFF	OFF	OFF	OFF	OFF	OFF	RUN/STOP
	OFF	ON	OFF	OFF	OFF	OFF	OFF	OFF	ERROR 2
	OFF	OFF	ON	OFF	OFF	OFF	OFF	OFF	ERROR 3
	OFF	OFF	OFF	ON	OFF	OFF	OFF	OFF	ERROR 4
	OFF	OFF	OFF	OFF	ON	OFF	OFF	OFF	ERROR 5
	OFF	OFF	OFF	OFF	OFF	ON	OFF	OFF	ERROR 6
	OFF	OFF	OFF	OFF	OFF	OFF	ON	OFF	ERROR 7
	OFF	OFF	OFF	OFF	OFF	OFF	OFF	ON	ERROR 8
PTN	ON	OFF	OFF	-	-	-	-	-	RUN
	OFF	ON	OFF	-	-	-	-	-	STOP
	OFF	OFF	ON	-	-	-	-	-	HOLD
	OFF	OFF	OFF	ON	-	-	-	-	STEP
	-	-	-	-	OFF	OFF	OFF	OFF	PATTERN 1
	-	-	-	-	ON	OFF	OFF	OFF	PATTERN 2
	-	-	-	-	OFF	ON	OFF	OFF	PATTERN 3
	-	-	-	-	ON	ON	OFF	OFF	PATTERN 4
	-	-	-	-	OFF	OFF	ON	OFF	PATTERN 5
	-	-	-	-	ON	OFF	ON	OFF	PATTERN 6
	-	-	-	-	OFF	ON	ON	OFF	PATTERN 7
	-	-	-	-	ON	ON	ON	OFF	PATTERN 8
	-	-	-	-	OFF	OFF	OFF	ON	PATTERN 9
	-	-	-	-	ON	OFF	OFF	ON	PATTERN 10
	-	-	-	-	OFF	ON	OFF	ON	PATTERN 11
	-	-	-	-	ON	ON	OFF	ON	PATTERN 12
	-	-	-	-	OFF	OFF	ON	ON	PATTERN 13
	-	-	-	-	ON	OFF	ON	ON	PATTERN 14
-	-	-	-	OFF	ON	ON	ON	PATTERN 15	
-	-	-	-	ON	ON	ON	ON	PATTERN 16	

2.12.6.2 DI ERROR NAME SET

Figure 2-67. DI Error Name Setting Screen

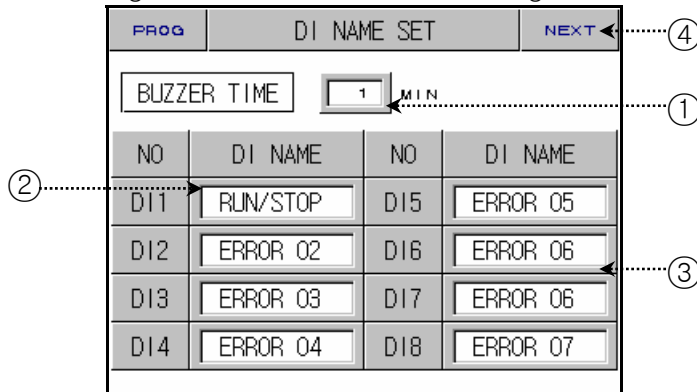

No.	Instruction	Contents	Additional Explanation
①	BUZZER TIME	Sets time for DI Error buzzer.	▶ Although it is set to “0”, alarm goes off for at least one minute.
②	DI1	Using DI1, you can select operation status (RUN / STOP).	☞ Cannot amend.
③	DI2 ~ DI8 NAME SET	You can set DI error name up to nine letters (English or number).	▶ Refer to 2.10.6.1 How To Set Pattern Name for DI name setting.
④	NEXT BUTTON	Moves to Alarm Setting Screen.	▶ Refer to 2.12.6.1 Alarm Setting

2.12.6.3 SCREEN DURING DI ERROR OCCURRENCE

Figure 2-68. Screen During DI Error Occurrence

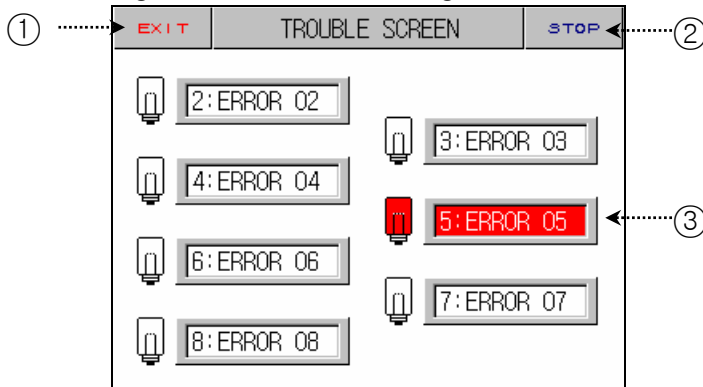

No.	Instruction	Contents	Additional Explanation
①	EXIT BUTTON	Exits error screen.	▶ Returns to Operation Screen. ☞ Displays error screen again if error is not resolved.
②	STOP BUTTON	Turns off alarm sound.	
③	DI ERROR ON	Reverses lamp and name of DI which has error.	▶ Displays red. ☞ It becomes green after error is removed.

☞ Operation stops if DI2~DI8 error occurs

2.12.7 COMMUNICATION SET

► Screen for communication setting.

Figure 2-69. Communication Setting Screen

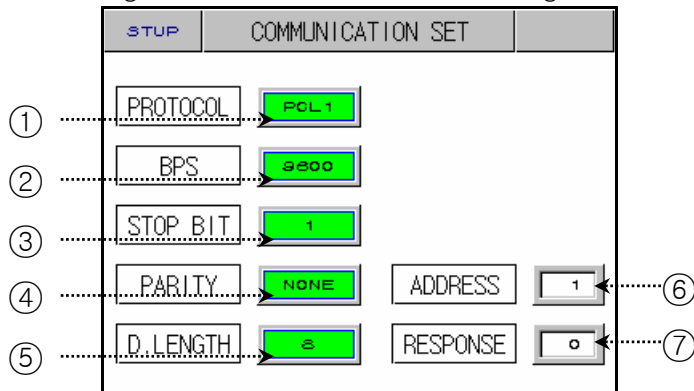

No.	Instruction	Contents	Additional Explanation
①	PROTOCOL	Sets communication protocol.	► Operating Program for the company is PC LINK1(SUM CHECK)
②	BIT PER SEC	Sets communication speed.	
③	STOP BIT	Sets stop bit.	
④	PARITY	Sets parity.	
⑤	DATA LENGTH	Sets data length.	
⑥	ADDRESS	Sets address.	► It can be used by connecting and designating different addresses up to 99 when communicating via RS485.
⑦	RESPONSE TIME	Sets response time.	

2.12.8 INITIAL DISPLAY and STAUS DISPLAY LAMP SET

2.12.8.1 Initial Display Setting

Figure 2-70. Initial Display Setting Screen

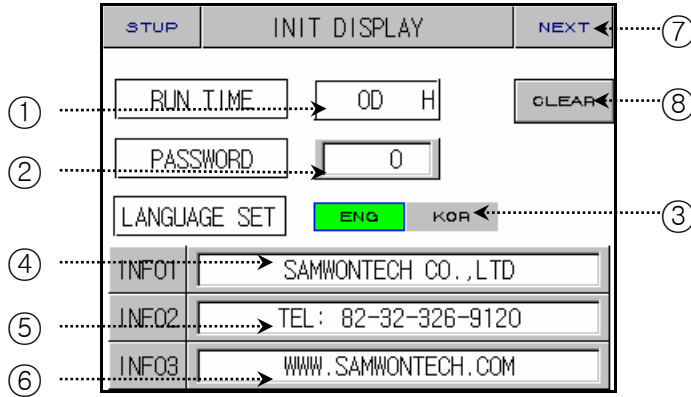

No.	Instruction	Contents	Additional Explanation
①	RUN TIME	Records total run (operation) time.	
②	PASSWORD SET	Setup password when entering <u>2.12 System Setting</u> .	<ul style="list-style-type: none"> ▶ The Setting value is “0” when sec is delivered from a factory. ▶ Contact where you purchased the product or the company if you forgot password. ☞ All data will be initialized to a state of being delivered from a factory.
③	LANGUAGE SET	Selects language (English or Chinese)	<ul style="list-style-type: none"> ▶ System inner setting screen displays English regardless of a kind of language.
④	INFORMATION1	You can enter company name up to 18 letters of number and English combined.	
⑤	INFORMATION2	You can enter company phone number up to 18 letters of number and English combined.	
⑥	INFORMATION3	You can enter company website address up to 18 letters of number and English combined.	
⑦	NEXT BUTTON	Moves to Status Display Lamp Setting Screen.	<ul style="list-style-type: none"> ▶ Refer to <u>2.12.8.2 Status Display Lamp Setting</u>
⑧	CLEAR BUTTON	Delete total Operation Time.	

2.12.8.2 STATUS DISPLAY LAMP SETTING

Figure 2-71. Status Display Lamp Setting Screen

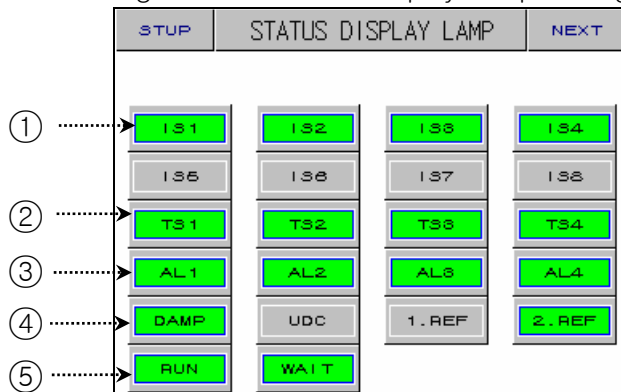

No.	Instruction	Contents	Additional Explanation
①	IS1 ~ IS8	Inner signal displaying lamp.	<ul style="list-style-type: none"> ▶ Up to 16 lamps can be selected. ▶ Selected lamp becomes green. ▶ Selected lamp is displayed on fix operation or the second screen of program operation.
②	TS1 ~ TS4	Time signal displaying lamp.	
③	AL1 ~ AL4	Alarm signal displaying lamp.	
④	DAMP	Auxiliary output displaying lamp.	
	UDC	UDC Operation signal lamp.	
	1.REF	Signal displaying lamp for the 1st cooler operation.	
	2.REF	Signal displaying lamp for the 2 nd cooler operation.	
⑤	RUN	Operation signal displaying lamp.	
	WAIT	Wait operation displaying lamp.	

2.13 SETUP PASSWORD

- ▶ Inputs password for entering System Setting Screen or Section Input Revision Screen.

Figure 2-72. Setup Password Screen – System Setting

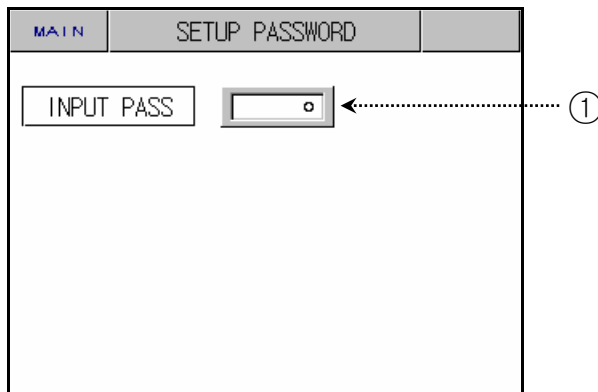
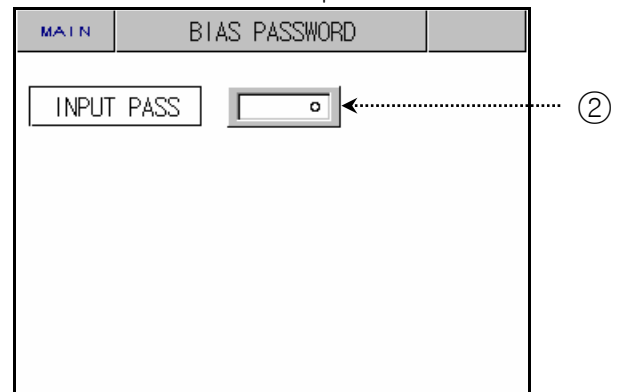

Figure 2-73. Password input Screen – Section Input Revision



No.	Instruction	Contents	Additional Explanation
①	INPUT PASSWORD	Inputs password for entering System Setting Screen	▶ password for sec is "0" 👁 Switch password at <u>2.12.8.1 sec Display Setting.</u>
②	INPUT PASSWORD	Inputs password for entering input revision screen.	

▪ Simple Program EXAMPLE

► How to set parameter of TEMP 880 when you wish to occur different kinds of signal and patterns as below.

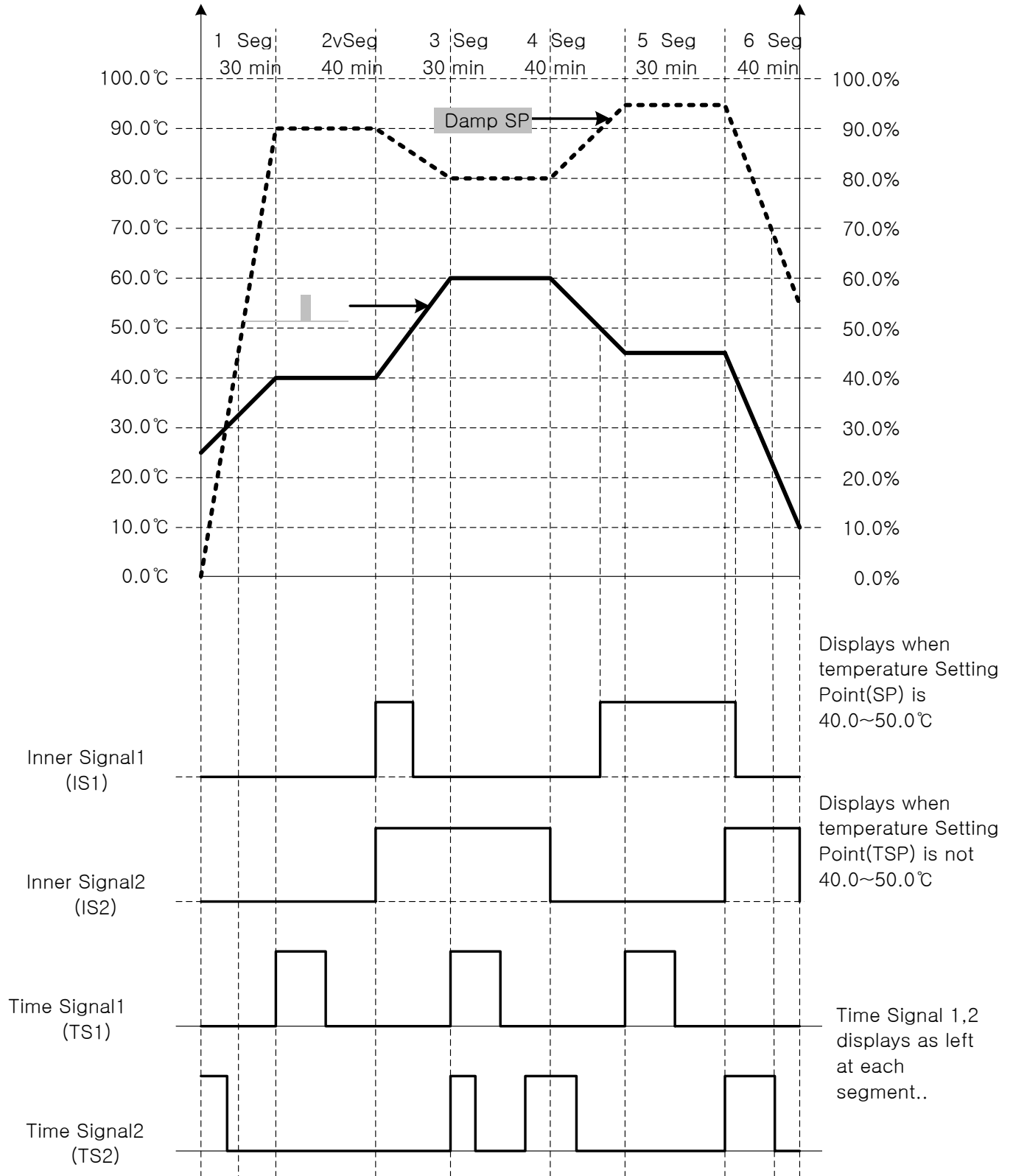

① Sets pattern.

PROG		PATTERN SET				INFO			
PTN NO		001		SSP		25.00			
SEG	TEMP	DAMP	TIME	TS ₁	TS ₂	TS ₃	TS ₄		
01	40.00	90.0	0.30	00	00	00	00		
02	40.00	90.0	0.40	00	00	00	00		
03	60.00	80.0	0.30	00	00	00	00		
04	60.00	80.0	0.40	00	00	00	00		
PGUP		PGDN		INSERT		DELETE			

PROG		PATTERN SET				INFO			
PTN NO		001		SSP		25.00			
SEG	TEMP	DAMP	TIME	TS ₁	TS ₂	TS ₃	TS ₄		
05	45.00	95.0	0.30	00	00	00	00		
06	45.00	95.0	0.40	00	00	00	00		
07	10.00	55.0	0.30	00	00	00	00		
08	-50.00	0.0	-0.01	00	00	00	00		
PGUP		PGDN		INSERT		DELETE			

② Sets Inner Signal

STUP		INNER SIGNAL SET			NEXT	
IS LIST						
NO	RANGE-L	RANGE-H	TIME			
IS1	40.0	50.0	00.00	▲		
	TEMP	SP	INB			
IS2	40.0	50.0	00.00			
	TEMP	TSP	OUTB	▼		

③ Sets time signal.

PROG		TIME SIGNAL SET			
TS NO(0-7)					
NO	ON TIME	OFF TIME			
00	TS OFF	TS OFF	▲		
01	TS ON	TS ON			
02	00.20 HH.MM	00.20 HH.MM			
03	00.10 HH.MM	00.20 HH.MM	▼		

PROG		PATTERN SET				INFO			
PTN NO		001		SSP		25.00			
SEG	TEMP	DAMP	TIME	TS ₁	TS ₂	TS ₃	TS ₄		
01	40.00	90.0	0.30	00	00	00	00		
02	40.00	90.0	0.40	00	00	00	00		
03	60.00	80.0	0.30	00	00	00	00		
04	60.00	80.0	0.40	00	00	00	00		
PGUP		PGDN		INSERT		DELETE			

PROG		PATTERN SET				INFO			
PTN NO		001		SSP		25.00			
SEG	TEMP	DAMP	TIME	TS ₁	TS ₂	TS ₃	TS ₄		
05	45.00	95.0	0.30	00	00	00	00		
06	45.00	95.0	0.40	00	00	00	00		
07	10.00	55.0	0.30	00	00	00	00		
08	-50.00	0.0	-0.01	00	00	00	00		
PGUP		PGDN		INSERT		DELETE			

3. PARAMETER SETTING

- Table that organizes setting range and sec standard of inner parameters for each screen.

2.7 Operation Setting				
Symbol	Parameter	Range	Unit	Default
OPER. MODE	OPERATION MODE	PROG, FIX	ABS	PROG
POWER MODE	POWER MODE	STOP, COLD, HOT	ABS	STOP
FUZZY SELECT	FUZZY SELECT	OFF, ON	ABS	OFF
KEY LOCK	KEY LOCK	OFF, ON	ABS	OFF
TIME UNIT	TIME UNIT	HH:MM, MM:SS	ABS	HH:MM
OPER. HOUR	OPERATION HOUR	0~9999	ABS	0
OPER. MIN	OPERATION MINUTE	0~59	ABS	0
TIME MODE	TIME MODE	OFF, ON	ABS	OFF
TEMP SLOPE	TEMP SLOPE	EUS(0~100%)/MIN	EUS/MIN	EUS(0%)/MIN
DAMP SLOPE	DAMP SLOPE	0.0 ~ 100.0	ABS	0.0/MIN
DISP	DISP	DISP , HIDE	ABS	DISP

2.8 Reserve Setting				
Symbol	Parameter	Range	Unit	Default
Y	YEAR	0~99	ABS	0, 1
M	MONTH	1~12	ABS	0, 1
D	DAY	1~31	ABS	0, 1
H	HOUR	0~23	ABS	0, 1
M	MINUTE	0~59	ABS	0, 0
RESERVE MODE	RESERVE MODE	OFF, ON	ABS	OFF

2.9 Graph and Graph Record Setting				
Symbol	Parameter	Range	Unit	Default
PTNO	PATTERN NUMBER	0~120	ABS	0
TEMP SP	TEMP SP DISPLAY	OFF, ON	ABS	ON
DAMP SP	DAMP SP DISPLAY	OFF, ON	ABS	ON
OPER. MODE	OPERATION MODE	STOP, RUN	ABS	STOP
TIME UNIT	TIME UNIT	SEC, MIN	ABS	SEC
SAMPLING TIME	SAMPLING TIME	1~59	ABS	5
BACK UP	SELECT BACK UP	PTN, PARA, ALL	ABS	PTN
DIRECT	SELECT DIRECT	DNLOAD, UPLOAD	ABS	DNLOAD

2.10.1 Pattern Edit

Symbol	Parameter	Range	Unit	Default
PATTERN NO	PATTERN NUMBER	1~120	ABS	1
TEMP	SEGMENT TEMP SP	EU(0~100%)	EU	EU(0%)
STC	START CODE	SSP, S.PV, T.PV	ABS	S.PV
SSP	START SET POINT	EU(0~100%)	EU	EU(0%)
DAMP	SEGMENT DAMP SP	0.0 ~ 100.0	ABS	0.0
TIME	SEGMENT TIME	-0.01(OFF)~99.59 (HOUR.MIN)	ABS	-0.01(OFF)
TS1~TS4	TIME SIGNAL1~4	0~7	ABS	0(OFF)

2.10.2 Repeat Setting

Symbol	Parameter	Range	Unit	Default
PTN NO	PATTERN NUMBER	1~120	ABS	1
PTN RPT	PATTERN REPEAT COUNT	0(infinite repeat)~999	ABS	1
LINK PTN	LINK PATTERN	0~120	ABS	0
START	START SEGMENT	0~99	ABS	0
END	END SEGMENT	0~99	ABS	0
COUNT	SEGMENT COUNT	0~99	ABS	0

2.10.3 File Edit

Symbol	Parameter	Range	Unit	Default
SRC. PTNO	SOURCE PATTERN NUMBER	1~120	ABS	0
DES. PTNO	DESTINATION PATTERN NUMBER	1~120	ABS	0
DEL. PTNO	DELETE PATTERN NUMBER	1~120	ABS	0

2.10.4 Time Signal Setting

Symbol	Parameter	Range	Unit	Default
ON TIME	TIME SIGNAL ON TIME	00.00~99.59 (HOUR.MIN)	ABS	00.00
OFF TIME	TIME SIGNAL OFF TIME	00.00~99.59 (HOUR.MIN)	ABS	00.00

2.10.5 Wait Operation Setting

Symbol	Parameter	Range	Unit	Default
WAIT MODE	WAIT MODE	OFF, ON	ABS	OFF
TEMP ZONE	TEMP WAIT ZOME	EUS(0~100%)	EUS	EUS(0%)
WAIT TIME	WAIT TIME	00.00~99.59 (HOUR.MIN)	ABS	00.00

2.10.6 Pattern Name Setting Screen

Symbol	Parameter	Range	Unit	Default
PTNO 1~120	PATTERN NAME 1~120	0~9, A~Z, Special Character (Max.10 Character)	ABS	PROG PT001 ~ PROG PT120

2.11 Screen Choice

Symbol	Parameter	Range	Unit	Default
TUNING KEY	TUNING KEY DISPLAY BUTTON	HIDE, DISP	ABS	DISP
LIGHT OFF	LIGHT OFF	0~99	ABS	10
CONTRAST SET	CONTRAST GROUP SET	8 Level	ABS	4 Level

2.12.1.1 Temperature Input Setting

Symbol	Parameter	Range	Unit	Default
SENSOR GROUP	SENSOR GROUP	TC , RTD , DCV	ABS	T C
SENSOR SET	SENSOR SET	Refer to Page53 Input Sign	ABS	T C-K1
SENSOR UNIT	SENSOR UNIT	°C, °F	ABS	°C(TC,RTD)
		°C, °F, SPACE, %, Pa, mV, V, %Rh, OHM	ABS	°C(DCV)
RANGE SET	RANGE HIGH	EU(0~100%)	EU	EU(100%)
	RANGE LOW	TEMP RL < TEMP RH	EU	EU(0%)
DOT POSITION	DOT POSITION	0 ~ 3	ABS	1
ALL BIAS	ALL BIAS	EUS(-105~105%)	EUS	EUS(0%)
FILTER TIME	FILTER TIME	0~120 SEC	ABS	0
SCALE SET	SCALE HIGH	-199.9~3000.0	ABS	100.0
	SCALE LOW	SL < SH	ABS	0.0
TC SELECT	TC SELECT	TC, T+R, RTC	ABS	T+R

2.12.1.2 Section Input Revision Setting

Symbol	Parameter	Range	Unit	Default
POINT1.DDV POINT2.DDV POINT3.DDV POINT4.DDV POINT5.DDV POINT6.DDV POINT7.DDV POINT8.DDV	DIFFERENCE VALUE1~8	EUS(-10~10%)	EUS	EUS(0%)
POINT1.DPV	REFERENCE POINT1	EU(0~100%)	EU	EU(0%)

POINT2.DPV	REFERENCE POINT2	DRY RL \leq POINT1.DPV \leq POINT2.DPV \leq POINT3.DPV \leq POINT4.DPV \leq POINT5.DPV \leq POINT6.DPV \leq POINT7.DPV \leq POINT8.DPV \leq DRY.RH	EU	EU(100%)
POINT3.DPV	REFERENCE POINT3		EU	EU(100%)
POINT4.DPV	REFERENCE POINT4		EU	EU(100%)
POINT5.DPV	REFERENCE POINT5			
POINT6.DPV	REFERENCE POINT6			
POINT7.DPV	REFERENCE POINT7			
POINT8.DPV	REFERENCE POINT8			

2.12.2.1 Control Output Setting

Symbol	Parameter	Range	Unit	Default
HEAT OUTPUT	HEAT OUTPUT TYPE	SSR, SCR	ABS	SSR
HEAT CYCLE	HEAT CYCLE TIME	1~300 SEC	ABS	1
HEAT AT-GAIN	HEAT AUTO TUNING GAIN	0.1~10.0	ABS	1.0
H.PRESET OUT	HEAT PRESET OUTPUT	-5.0~105.0%	%	0.0%
DIRECTION	OUTPUT DIRECTION	REV, FWD	ABS	REV
COOL OUTPUT	COOL OUTPUT TYPE	SSR, SCR, NONE	ABS	NONE
COOL CYCLE	COOL CYCLE TIME	1~300 SEC	ABS	1
COOL AT-GAIN	COOL AUTO TUNING GAIN	0.1~10.0	ABS	1.0
C.PRESET OUT	COOL PRESET OUTPUT	-5.0~105.0%	%	0.0%
ARW SET	ANTI RESET WIND-UP	0.0(AUTO)~200.0	%	100.0

2.12.2.2 Transmission Output Setting

Symbol	Parameter	Range	Unit	Default
RET. SELECT	RETRANSMISSION SELECT	PV, SP, MV, HMV, CMV	ABS	PV
RET. RANGE	RETRANSMISSION RANGE HIGH	EU(0~100%)	EU	EU(100%)
	RETRANSMISSION RANGE LOW	RET RL < RET RH	EU	EU(0%)

2.12.3 Inner Signal

Symbol	Parameter	Range	Unit	Default
RANGE-L	INNER SIGNAL RANGE LOW	EU(0~100%) RANGE-L ≤ RANGE-H	EU	EU(0%)
RANGE-H	INNER SIGNAL RANGE HIGH		EU	EU(0%)
TIME	INNER SIGNAL DELAY TIME	00.00~99.59 (HOUR.MIN)	ABS	00.00
TYPE	INNER SIGNAL TYPE	SP, PV, TSP	ABS	SP
BAND	INNER SIGNAL BAND DIRECT	INB, OUTB	ABS	INB

2.12.4.1 PID Range Setting

Symbol	Parameter	Range	Unit	Default
RP1	REFERENCE POINT1	RL≤RP1≤RP2≤RH	EU	EU(100%)
RP1	REFERENCE POINT2			
RDV	REFERENCE DEVIATION	EUS(0.0~100.0%)	EUS	EUS(0.0%)
RHY	REFERENCE HYSTERESIS	EUS(0.0~100.0%)	EUS	EUS(0.3%)
RUNNING PID NO	RUNNING PID NUMBER	1,2,3,4	ABS	1
CONTROL MODE	CONTROL MODE	D.DV, D.PV	ABS	D.DV

2.12.4.2 PID Group (PID1~PID4) Setting

Symbol	Parameter	Range	Unit	Default
P	PROPORTIONAL BAND	0.1~999.9%	ABS	5.0%
I	INTEGRAL TIME	0~6000S	ABS	120S
D	DERIVATIVE TIME	0~6000S	ABS	30S
DB	DEAD BAND	-100.0%~15.0	%	3.0%
MR	MANUAL RESET	-5.0~105.0%	%	50.0%
OH	OUTPUT LIMIT HIGH	0.0~100.0 OL < OH	ABS	100.0
OL	OUTPUT LIMIT LOW		ABS	0.0

2.12.5 DO CONFIG Setting				
Symbol	Parameter	Range	Unit	Default
IS1~IS8 RELAY	INNER SIGNAL1~8 RELAY	0(OFF)~20	ABS	0
TS1~TS4 RELAY	TIME SIGNAL1~4 RELAY	0(OFF)~20	ABS	0
AL1~AL4 RELAY	ALARM SIGNAL1~4 RELAY	0(OFF)~20	ABS	0
RUN RELAY	RUN RELAY	0(OFF)~20	ABS	0
RUN CPARA	RUN DELAY TIME	0~999 SEC	ABS	0
UP RELAY	UP RELAY	0(OFF)~20	ABS	0
UP CPARA	UP RANGE	EUS(0~10%)	EUS	EUS(0%)
SK RELAY	SOAK RELAY	0(OFF)~20	ABS	0
SK CPARA	SOAK TIME	0~999 MIN	ABS	0
DN RELAY	DOWN RELAY	0(OFF)~20	ABS	0
DN CPARA	DOWN RANGE	EUS(0~10%)	EUS	EUS(0%)
ERROR RELAY	ERROR RELAY	0(OFF)~20	ABS	0
ERROR CPARA	ERROR TIME	0~999 MIN	ABS	0
PTEND RELAY	PATTERN END RELAY	0(OFF)~20	ABS	0
PTEND CPARA	PATTERN END TIME	0~999 MIN	ABS	0
1REF RELAY	FIRST REF. RELAY	0(OFF)~20	ABS	0
1REF CPARA	FIRST REF. TIME	0~999 SEC	ABS	0
2REF RELAY	SECOND REF. RELAY	0(OFF)~20	ABS	0
2REF CPARA	SECOND REF. TIME	0~999 MIN	ABS	0

2.12.6.1 Alarm Setting				
Symbol	Parameter	Range	Unit	Default
DI SELECT	DI SELECT	ERR, PTN	ABS	ERR
TYPE	ALARM TYPE	AH.F, AL.F, DH.F DL.F, DH.R, DL.R DO.F, DI.F, AH.R AL.R, AH.FS, AL.FS DH.FS, DL.FS, DH.FS DL.RS, DO.FS, DI.FS AH.RS, AL.RS	ABS	ALARM1,3 → AH.F ALARM2,4 → AL.F
POINT	ALARM POINT	EU(-105~105%)	EU	EU(100%)
HYS	ALARM HYSTERESIS	EUS(0~100%)	EUS	EUS(0.5%)

2.12.6.2 DI Error Name Setting				
Symbol	Parameter	Range	Unit	Default
BUZZER TIME	BUZZER TIME	0~99 MIN	ABS	1
DI2~DI8 NAME	DI2~DI8 NAME	0~9, A~Z, Special Character (Max of 9 letters)	ABS	DI2:ERROR 02 DI3:ERROR 03 DI4:ERROR 04 DI5:ERROR 05 DI6:ERROR 06 DI7:ERROR 07 DI8:ERROR 08

2.12.7 Communication Setting				
Symbol	Parameter	Range	Unit	Default
PROTOCOL	PROTOCOL	PCL0 (PC LINK) PCL1(PC LINK with SUM CHECK) MODA(MODBUS ASCII), MODR(MODBUS RTU), SYNM (SYNC MASTER)	ABS	PCL1
BPS	BIT PER SEC	600, 1200, 2400, 4800, 9600	ABS	9600
STOP BIT	STOP BIT	1, 2	ABS	1
PARITY	PARITY	NONE, EVEN, ODD	ABS	NONE
D.LENGTH	DATA LENGTH	7, 8	ABS	8
ADDRESS	ADDRESS	1 ~99 (Maximum of 99)	ABS	1
RESPONSE	RESPONSE TIME	0~10	ABS	0

2.12.8 Initial Display Setting

Symbol	Parameter	Range	Unit	Default
PASSWORD SET	PASSWORD SET	0~9999	ABS	0
LANGUAGE SET	LANGUAGE SET	ENG, CHN	ABS	ENG
INFORMATION1	COMPANY INFORMATION	0~9, A~Z, Special Character (Max of 9 letters)	ABS	SAMWONTECH CO.,LTD
INFORMATION2	TELEPHONE INFORMATION	0~9, A~Z, Special Character (Max of 9 letters)	ABS	TEL: 82-32-326-9120
INFORMATION3	HOME PAGE INFORMATION	0~9, A~Z, Special Character (Max of 9 letters)	ABS	WWW.SAMWONTECH.COM

4. Communication Manual

4.1 Communication Specification

- ▶ TEMP880 adopts the Half-Duplex type of Communication Interface (RS232C or RS485).
In case the Communication Option is RS232C, it is possible to communicate by one to one with a superior rank of communication equipment such as PC. Especially the model of RS485, it can be used by connecting to a superior rank of communication equipment up to the number of 99.
- ▶ TEMP880 uses the following parameter during the communication.

PARAMETER	Setting Value	Contents
PROTOCOL	PCL0	Basic Protocol
	PCL1	Basic Protocol + Check Sum
	MODA	MODBUS ASCII
	MODR	MODBUS RTU
	SYNM	SYNC MASTER
Communication Speed(BPS)	9600	9600 bps
	4800	4800 bps
	2400	2400 bps
	1200	1200 bps
	600	600 bps
PARITY	NONE	None Parity
	EVEN	Even Parity
	ODD	Odd Parity
STOP BIT	1	1 bit
	2	2 bits
DATA LENGTH	8	8 bits
	7	7 bits
ADDRESS	1~99	Address
RESPONSE	0~10	RESPONDING TIME (=PROCESSING TIME+RESPONSE*10msec)

- Communication related parameter basic value when forwarding from factory

- PROTOCOL : PCL1(PC LINK+ Check Sum)
- BPS : 9600 bps
- PARITY : NONE
- STOP BIT : 1 (1 bit)
- DATA LENGTH : 8 (8 bits)
- ADDRESS : 1
- RESPONSE : 0 (dealing time + 10 msec)

4.2 Communication Wiring

- ▶ Wiring between the TEMP880 and superior rank of communication equipment is different by the option(RS232C/RS485) of TEMP880 and the contents are as below.

4.2.1 Connecting the TEMP880 9 Pin connector of RS232C Communication

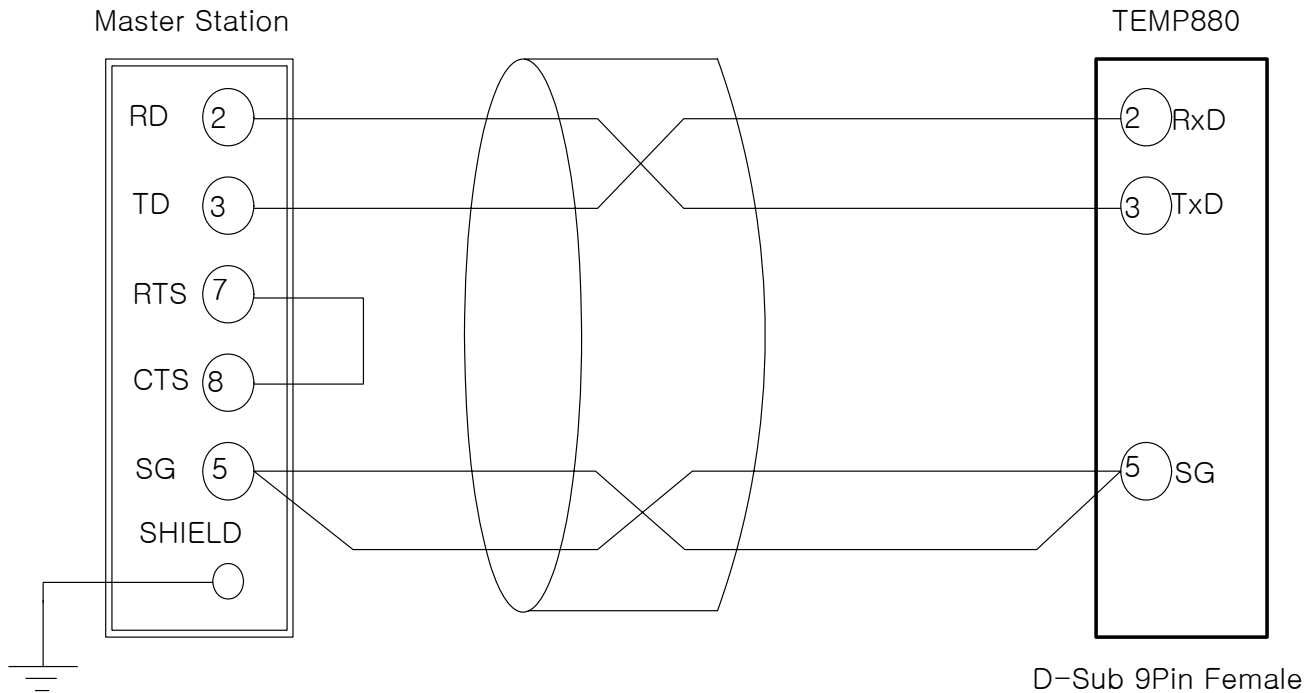

4.2.2 Connecting the terminal plate of TEMP880 of RS485 Communication

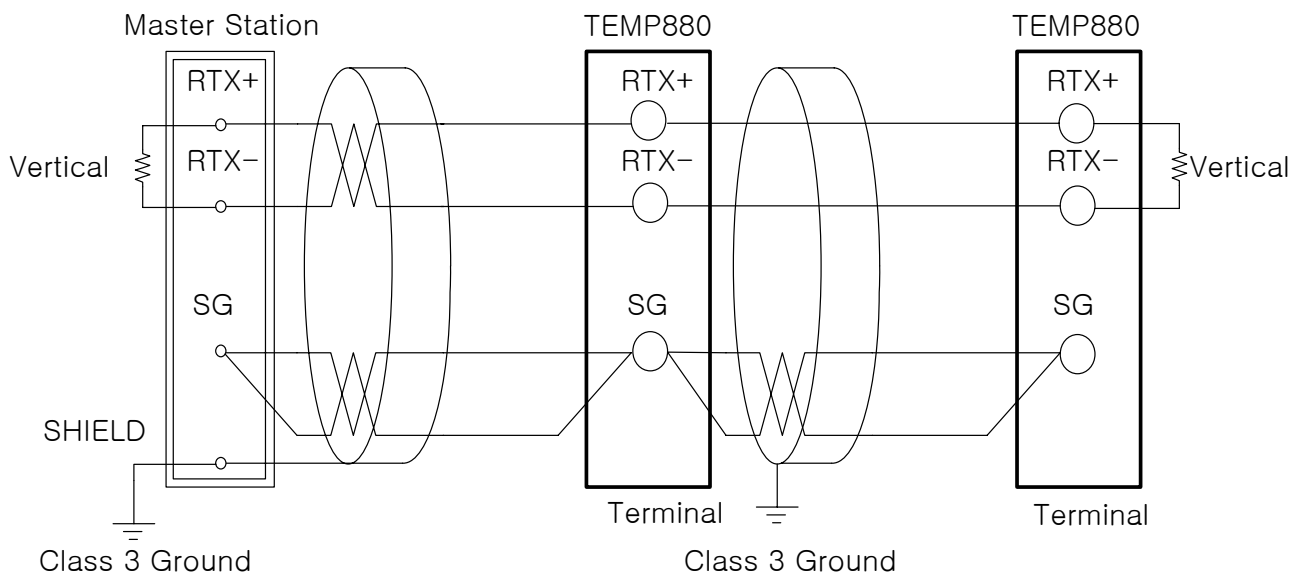

- ☞ MULTIDROP is possible up to the number of 99 in case of SLAVE(TEMP880).
- ☞ Make sure to connect the vertical section resistance (200Ω 1/4W) in case of the TEMP880 or MASTER(PC, PLC etc.)

4.3 Communication Command

4.3.1 Composition of Communication Command

- The basic style of Communication Command which transmits a message to TEMP880 from a superior rank of Communication equipment.

①	②	③	④	⑤	⑥	⑦	⑧
S T X	ADDRESS	COMMAND	,	Date followed by the rule of COMMAND	SUM	C R	L F

- ① Beginning letter of Communication Command
Indicate the beginning of Communication Command having a code value (0x02) with a STX (Start of Text), which is a letter of Ascii.
- ② ADDRESS
Indicate the ADDRESS which is a number of TEMP880 that you intend to communicate with.
- ③ COMMAND
COMMAND for Communication (refer to 4.3.2~4.3.9).
- ④ Divider
Indicate the Divider which separates the Command and Data by comma (',').
- ⑤ Data part
Indicate the letter line which has a regular form of a letter line followed the Communication Command Rule
- ⑥ Check Sum
Indicate the inferior rank of 2-byte to D by adding all letters from the letter of after STX to the letter of before SUM using the Ascii code and Use only when the protocol of TEMP880 is "the basic protocol of "PCL!" + Check Sum"
- ⑦, ⑧ Vertical Section letter
Indicate the end of Communication Command as CR(0x0D), LF(0x0A) by using the Ascii code.

4.3.2 The Kind of Communication Command

- ▶ The Communication Command of TEMP880 has a Self Information Command which reads the information of Communication Command and a Read/Write Command which reads all the information of TEMP880.

① Self Information Command

COMMAND	Contents
AMI	Indicate the model name & version of TEMP880

② Read/Write Command

COMMAND	Contents
RSD	Series Read of D-Register
RRD	Random Read of D-Register
WSD	Series Write of D-Register
WRD	Random Write of D-Register
STD	Random Registration of D-Register
CLD	Call of D-Register which is registered at STD

- ☞ Each Command can read or write D-Register up to the number of 32. And it should be re-registered after the power is on in case of STD/CLD when its power source's off because the registered contents are initialized.

4.3.3 Error Response

- ▶ Transmit a message as below in case of Error during a Communication.

The number of Byte	1	2	2	2	2	1	1
Contents	S T X	Address	NG	숫자2개	SUM	C R	L F

- ☞ SUM is only used in case the PROTOCOL is "PCL1".

4.3.4 RSD Command

▶ RSD Command is used for reading a series of Data on D-Register.

▶ Format of Transmission

The number of Byte	1	2	3	1	2	1	4	2	1	1
Contents	S T X	Addr.	RSD	,	The number	,	D-Reg. No.	SUM	C R	L F

▶ Response

The number of Byte	1	2	3	1	2	1	4	1	4	1	...
Contents	S T X	Addr.	RSD	,	OK	,	dddd-1	,	dddd-2	,	...

1	4	1	4	2	1	1
,	dddd-(n-1)	,	dddd-(n)	SUM	C R	L F

- The Number of : 1~32
- dddd : Data without a point of decimal number (D)

ex) In case of reading a D-Register from Temperature PV(D0001) to SP(D0002)

- Transmission : [stx]01RSD,02,0001[cr][lf]
- Transmission (including Check Sum) : [stx]01RSD,02,0001C5[cr][lf]
 ([stx] = 0x02, [cr] = 0x0d, [lf] = 0x0a)

In case the received value of each PV, SP is 50.0 and 30.0, will be received as below ; - Reception

- : [stx]01RSD,OK,01F4,012C[cr][lf]
- Reception (including Check Sum) : [stx]01RSD,OK,01F4,012C19[cr][lf]

※ The process of transforming the PV value of received D data to display on screen.

- ① Transformation to decimal number : 01F4(16 number-D-) → 500(decimal number)
- ② Multiply 0.1 to the transformed value. : 500 * 0.1 → 50.0

4.3.5 RRD Command

▶ RRD Command is used in case of reading the Random Data on D-Register.

▶ Format of Transmission

The number of Byte	1	2	3	1	2	1	4	1	4	1	...
Contents	S T X	Addr	RRD	,	개수	,	D-Reg. No1	,	D-Reg. No2	,	...

1	4	1	4	2	1	1
,	D-Reg. No(n-1)	,	D-Reg. No(n)	SUM	C R	L F

▶ Response

The number of Byte	1	2	3	1	2	1	4	1	4	1	...
Contents	S T X	Addr	RRD	,	OK	,	dddd-1	,	dddd-2	,	...

1	4	1	4	2	1	1
,	dddd-(n-1)	,	dddd-n	SUM	C R	L F

- The number of (~) : 1~32
- dddd : Data without a point of decimal number (number D)

ex) In case of reading the D-Register of PV(D0001), SP(D0002)

- Transmission : [stx]01RRD,02,0001,0002[cr][lf]
- Transmission (Including Check Sum) : [stx]01RRD,02,0001,0002B2[cr][lf]

In case the value of D0001 is 50.0 and the value of D0002 is 30.0

- Reception : [stx]01RRD,OK,01F4,012C[cr][lf]
- Reception (including Check Sum) : [stx]01RRD,OK,01F4,012C18[cr][lf]

4.3.6 WSD Command

▶ WSD Command is used in case or using the series data of D-Register.

▶ Format of Reception

The number of Byte	1	2	3	1	2	1	4	1	4	1	...
Contents	S T X	Addr	WSD	,	The number	,	D-Reg. No1	,	dddd-1	,	...

1	4	1	4	2	1	1
,	dddd-(n-1)	,	dddd-(n)	SUM	C R	L F

▶ Response

The number of Byte	1	2	3	1	2	2	1	1
Contents	S T X	Addr	WSD	,	OK	SUM	C R	L F

- The number of (~) : 1~32

- dddd : Data without a point of prime number (number D)

ex) In case of using the data for the temperature & supplementation SP(D0103) when driving the FIX

- Set up the Temperature SP : 50.0 °C → Removal the point of decimal number (500)
→ move D number (0x01F4)

- Set up the Supplementation SP : 80.0 % → Removal the point of decimal number(800)
→ move to D number(0x0320)

- Transmission : [stx]01WSD,02,0102,01F4,0320[cr][lf]

- Transmission(including Check Sum) : [stx]01WSD,02,0102,01F4,0320C4[cr][lf]

4.3.7 WRD Command

▶ WRD Command is used for using the Random data of D-Register.

▶ Format of Transmission

The number of Byte	1	2	3	1	2	1	4	1	4	1	...
Contents	S T X	Addr	WRD	,	No. of contents	,	D-Reg. No1	,	dddd-1	,	...

1	4	1	4	2	1	1
,	D-Reg. No(n)	,	dddd-(n)	SUM	C R	L F

▶ Response

The number of Byte	1	2	3	1	2	2	1	1
Contents	S T X	Addr	WRD	,	OK	SUM	C R	L F

- The number : 1~32
- dddd : Data without a point of decimal number of D

ex) In case of using the temperature, SP(D0102) while driving the FIX and date at TEMP SLOPE(D0106)

- Set up the temperature SP : 50.0 °C → Removal the point of decimal number(500)
→ move to D number(0x01F4)
- Set up the TEMP SLOPE : 0.5 °C → Removal the point of decimal number (5)
→ move to D number (0x0005)
- Transmission : [stx]01WRD,02,0102,01F4,0106,0005[cr][lf]
- Transmission(including Check Sum) : [stx]01WRD,02,0102,01F4,0106,0005B6[cr][lf]

4.3.8 STD Command

▶ STD Command is used for registering preferable D-Register to TEMP880 in advance.

▶ Format of Transmission

The number of Byte	1	2	3	1	2	1	4	1	4	1	...
Contents	S T X	Addr	STD	,	The number	,	D-Reg. No1	,	D-Reg. No2	,	...

1	4	1	4	2	1	1
,	D-Reg. No(n-1)	,	D-Reg. No(n)	SUM	C R	L F

▶ Response

The number of Byte	1	2	3	1	2	2	1	1
Contents	S T X	Addr	STD	,	OK	SUM	C R	L F

- The number of (~) : 1~32

ex) In case of registering the Temperature of PV(D0001), SP(D0002), Supplementation SP(D0003)

- Transmission : [stx]01STD,04,0001,0002,0003[cr][lf]
- Transmission (including Check Sum) : [stx]01STD,04,0001,0002,0003A6[cr][lf]

4.3.9 CLD Command

- ▶ CLD Command is used for reading & bring the D-Register which is already registered at TEMP880 by STD Command.

▶ Format of Transmission

The number of Byte	1	2	3	2	1	1
Contents	S T X	Addr	CLD	SUM	C R	L F

▶ Response

The number of Byte	1	2	3	1	2	1	4	1	4	1	...
Contents	S T X	Addr	CLD	,	OK	,	dddd-1	,	dddd-2	,	...

1	4	1	4	2	1	1
,	dddd-(n-1)	,	dddd-(n)	SUM	C R	L F

- The number of (~) : 1~32
- dddd : Data without a point of decimal number (D)

4.4 Explanation of D-REGISTER

- ▶ D-Register is a group of gathering all the data which is provided to check all the condition of TEMP880. D-Register is grouped by each 100 unit, basically, depending on the contents and the contents are as below.

Scope of D-Register	Group	Contents	Read	Write
D0001~D0099	PROCESS	Indication of a basic driving-related information	○	X
D0100~D0199	FUNCTION	Set up the driving-related Information	○	△
D0200~D0299	RESERVATION	Set up the time and reservation functions	○	△
D0300~D0399	IS	Set up the inner-signal	○	○
D0400~D0499	ALARM / TS	Set up the Alarming and Time-signal	○	○
D0500~D0599	HEAT PID	Set up the P.I.D at heater	○	○
D0600~D0699	COOL PID	Set up the P.I.D at Freezer	○	○
D0700~D0799	COMM	Indication of communication-related information	○	X
D0800~D0899	OUTPUT	Set up the Control printing & DO printing	○	○
D0900~D0999	INPUT	Set up of input	○	○
D1000~D1099	PROGRAM	Set up the pattern of Program	○	○
D1100~D1199	RESERVED	Preparation	X	X
D1200~D1299	RESERVED	Preparation	X	X
D1300~D1399	FILE1	Indication the temperature TSP of segment	○	X
D1400~D1499	FILE2	Indication of supplement TSP of segment	○	X
D1500~D1599	FILE3	Indication of setting up time of segment	○	X
D1600~D1699	PROG_INFO	Set up the repeating of Pattern& Segment	○	○
D1700~D1799	FILE4	Set up the time-signal1 of segment	○	X
D1800~D1899	FILE5	Set up the time-signal2 of segment	○	X
D1900~D1999	FILE6	Set up the time-signal3 of segment	○	X
D2000~D2099	FILE7	Set up the time-signal4 of segment	○	X
D2100~D2399	RESERVED	Preparation	X	X

- ☞ Each of D-Register is composed of 4 places of D number (2-Byte).

4.4.1 PROCESS

- PROCESS group has basic data from the operation of TEMP880. Among this, there's Bit Map Information which indicates all the conditions by the unit of Bit and the contents are as below.

bit	NOWSTS (D0010)	OTHERSTS (D0011)	ISSTS (D0012)	TSSTS (D0013)	ALSTS (D0014)
0	RESET		IS1	TS1	AL1
1	FIX		IS2	TS2	AL2
2	PROG		IS3	TS3	AL3
3	HOLD		IS4	TS4	AL4
4	WAIT	RUN	IS5		
5	AT		IS6		
6		WAIT	IS7		
7	ERROR		IS8		
8					
9		1.REF			
10		2.REF			
11					
12					
13					
14					
15					

bit	SYSERR (D0015)	DOSTSL (D0016)	DOSTSH (D0017)	DIDATA (D0018)	ERROR (D0019)
0		RELAY 1	RELAY 17	DI1	TEMP +OVER
1		RELAY 2	RELAY 18	DI2	TEMP -OVER
2	SYS ERR	RELAY 3	RELAY 19	DI3	
3		RELAY 4	RELAY 20	DI4	
4		RELAY 5		DI5	
5		RELAY 6		DI6	
6		RELAY 7		DI7	
7		RELAY 8		DI8	
8		RELAY 9			
9		RELAY 10			
10		RELAY 11			
11		RELAY 12			
12		RELAY 13			
13		RELAY 14			
14		RELAY 15			
15		RELAY 16			

- ☞ It's composed of D-Register which has a real data value except the Bit Map information.

▶ Common Driving-related D-Register

D-Reg.	Signs	Contents
D0001	TEMP_NPV	Present Temperature PV
D0002	TEMP_NSP	Present Temperature SP
D0003	DAMP_NSP	Present DAMP SP
D0006	MVOUT	Temperature Control Printing Value
D0007	HOUT	Heater Control Printing Value
D0008	COUT	Freezer Control Printing Value
D0009	PIDNO	Currently Applied PID No.

▶ FIX Driving-related D-Register

D-Reg.	Signs	Contents
D0020	PROC_TIME_H	PROCESS TIME (hour) when driving FIX
D0021	PROC_TIME_L	PROCESS TIME (min) when driving FIX

▶ PROGRAM Driving-related D-Register

D-Reg.	Signs	Contents
D0025	PTNO	Program Pattern No. which is driving now
D0026	SEGNO	Segment No. which is driving now.
D0027	R_TIME_H	Remained time(hour) of Segment which is driving now
D0028	R_TIME_M	Remained time(min) of Segment which is driving now
D0029	WAITTIME_H	WAIT TIME(hour) when the WAIT motion
D0030	WAITTIME_M	WAIT TIME(min) when the WAIT motion
D0031	N_PT_RPT	Repeating frequency of a Pattern which is on the process
D0032	PT_RPT	Repeating frequency of a Pattern which is set up
D0033	N_SEG_RPT	Repeating frequency of a Segment which is on the process
D0034	SEG_RPT	Repeating frequency of a Segment which is set up
D0035	P_TEMP_TSP	Temperature TSP(Target Set Point) of previous Segment
D0036	N_TEMP_TSP	Temperature TSP(Target Set Point) of present Segment
D0037	P_DAMP_TSP	DAMP TSP(Target Set Point) of previous Segment
D0038	N_DAMP_TSP	DAMP TSP(Target Set Point) of present Segment
D0039	N_SEG_TIME	Set up time of Present Segment

4.4.2 FUNCTION

▶ FUNCTION Group is consist with a D-Register which is related to the motions of TEMP880.

▶ D-Register related to PROGRAM Driving

D-Reg.	Signs	Contents
D0100	SET_PTNO	Set up the No. of a pattern which is for driving a Program
D0120	WAITMD	Set up the condition whether or not to use the WAIT motion (0 : OFF 1 : ON)
D0121	TEMP_WZ	Set up the WAIT field of Temperature
D0122	WAIT_TM	Set up the time of WAIT motion

▶ D-Register related to FIX Driving

D-Reg.	Signs	Contents
D0102	FIX_T_SP	Set up the Temperature SP when driving FIX
D0103	FIX_D_SP	Set up the DAMP SP when driving FIX
D0110	OTMSL	Set up the condition whether or not to use FIX OP TIME (0 : OFF 1 : ON)
D0111	OTM_H	Set up the time(hour) of FIX OP TIME
D0112	OTM_M	Set up the time(min) of FIX OP TIME

▶ D-Register related to Motions

D-Reg.	Signs	Driving Contents	Setting Value	Contents
D0101	MODE	RUN	1	PROG/FIX RUN
		HOLD	2	HOLD ON/OFF
		STEP	3	Segment STEP
		STOP	4	PROG/FIX STOP
D0104	OPMODE	PROG	0	Set up the PROG MODE
		FIX	1	Set up the FIX MODE
D0105	PWRMODE	COLD	0	Set up the COLD MODE
		HOT	1	Set up the HOT MODE

☞ TEMP880 should be at the condition of STOP(PROG STOP/FIX STOP) to execute the PROG RUN or FIX RUN as a Communication. For example, to change the FIX RUN (present) to PROG RUN, it should be firstly done the change to PROG STOP(D0104=0001, D0101=0004) and then to PROG RUN.

4.4.3 RESERVATION

► RESERVATION group is consist of Time checking, Setting and Reservation-related D-Register of TEMP880.

► D-Register related to Time

D-Reg.	Signs	Contents	Read	Write
D0201	N_YEAR	Present time of TEMP880 (year)	○	×
D0202	N_MONTH	Present time of TEMP880 (month)	○	×
D0203	N_DAY	Present time of TEMP880 (day)	○	×
D0204	N_HOUR	Present time of TEMP880 (hour)	○	×
D0205	N_MIN	Present time of TEMP880 (min)	○	×
D0206	RUN_YEAR	Reservation time of TEMP880 (year)	○	○
D0207	RUN_MONTH	Reservation time of TEMP880 (month)	○	○
D0208	RUN_DAY	Reservation time of TEMP880 (day)	○	○
D0209	RUN_HOUR	Reservation time of TEMP880 (hour)	○	○
D0210	RUN_MIN	Reservation time of TEMP880 (min)	○	○
D0211	SET_YEAR	Set up the time (year)	×	○
D0212	SET_MONTH	Set up the time (month)	×	○
D0213	SET_DAY	Set up the time (day)	×	○
D0214	SET_HOUR	Set up the time (hour)	×	○
D0215	SET_MIN	Set up the time (min)	×	○

► Reservation work : ON/OFF

D-Reg.	Signs	Driving contents	Setting Value	Contents
D200	RESERVE	OFF	0	Cancellation of reservation
		ON	1	Setting of reservation

4.4.4 Set up the Pattern of Program

4.4.4.1 PROGRAM

- ▶ PROGRAM group is consist of D-Register for making Program Pattern with Communication.
- ▶ PROGRAM pattern should be set up at TEMP880 by changing the segment number one by one.
- ▶ D-Register related to PROGRAM Pattern

D-Reg.	Signs	Setting Value	Contents
D1000	P_PTNO	1~120	Set up the No. of Program Pattern when reading or writing
D1001	DEST_PTNO	1~120	Set up the No. of Program Pattern which will be copied when copying the Pattern
D1002	P_SEGNO	0	Set up at the position of D1603~D1618 when reading or writing
		1~99	Set up the Segment No. when reading or Writing
D1003	TRIGGER	1	INIT : Initializing the contents of D1000~D1004 to '0'
		2	READ : Reading with the contents which is set up at D1000 & D1002
		3	WRITE : Writing with the contents which is set up at D1000 & D1002
		4	PT COPY : Copying the pattern set up at D1000 to the pattern of D1001
		5	PT DEL : Deleting the pattern which is set up at D1000
		6	SEG INSERT : Inserting to the segment which is set up at D1000& D1002
		7	SEG DEL : Deleting the segment which is set up at D1000& D1002
		8	ALL PT : Indicating the contents which is set up at D1000 to under the D1300
D1004	ANSWER	0	FULL : Exceeding of the limited number of pattern or segment at TEMP880
		1	DONE : Order of D1003(TRIGGER) is managed normally
		2	PT EMPTY : No contents set up at a pertinent pattern
		3	SEG EMPTY : Not contents set up at a pertinent segment
		4	PT RUN : TEMP880 PROG RUN condition
		5	PARA ERROR : Setting Error of D1000~D1003
		6	PT USED : a pertinent pattern is the condition of PROG RUN
D1010	TEMP_TSP	-	Setting Value of Temperature TSP (Time Set Point) when reading or writing
D1011	DAMP_TSP	-	Setting Value of DAMP TSP(Time Set Point) when reading or writing
D1012	SEG_TIME	-	Set up time of a segment which to Read or Write
D1021	START_CODE	-	SP starting condition when beginning the Program
D1022	SSP_VALUE	-	Set up the START SP in case of STC=SSP

4.4.4.2 Reading a Program Pattern

▶ The following order should be performed to read the program pattern which is set up at TEMP880.

- ① Set up the Pattern No. of Program at D1000
- ② Set up the No. of Segment at D1002
- ③ Set up the READ TRIGGER ('2') at D1003
- ④ Wait until it's DONE ('1') after reading the data of D1004
- ⑤ Read the Temperature, DAMP, TSP and segment time recorded at D1010~D1012.

☞ The above Work from ① ~ ⑤ is reading a segment among those which are set up at Program Pattern. Repeat the work from ① ~ ⑤ by changing the No. of segment to read and bring several segment. If the D1002(②) is set up at '0', then the contents of D1603~D1618 are brought up.

4.4.4.3 Writing the Program Pattern

▶ The following order should be done to write program pattern at TEMP880.

- ① Set up the program pattern at D1000
- ② Set up the segment number at D1002
- ③ Set up the temperature, DAMP, TSP and segment time recorded at D1010~D1012.
- ④ Set up the WRITE TRIGGER ('3') at D1003
- ⑤ Wait until it's DONE ('1') after reading the data of D1004

☞ The above work from ① ~ ⑤ is to use one segment at program pattern. To use several segments at TEMP880, then change then No. of segment and repeat the work of ① ~ ⑤.

▶ The following order should be performed to set up the contents of D1603~D1618 at program writing.

- ① Set up the pattern No. of program at D1000
- ② Set up the No. of segment at D1002
- ③ Set up the READ TRIGGER ('2') at D1003
- ④ Set up the No. of pattern at D1000
- ⑤ Set up the No. of segment to '0' at D1002
- ⑥ Set up the pertinent data at D1603~D1618
- ⑦ Set up the WRITE TRIGGER ('3') at D1003
- ⑧ Wait until it's DONE ('1') after reading the data of D1004

4.4.4.4 Copy/Delete of Pattern & Insert/Delete of Segment

▶ Copy of Program Pattern

- ① Set up the original pattern No. to copy at D1000
- ② Set up the No. of pattern at D1001 to copy the original pattern
- ③ Set up D1003 PT COPY TRIGGER('4') at D1003
- ④ Wait until it's DONE ('1) after reading the data of D1004

▶ Delete of Program Pattern

- ① Set up the No. of pattern, which will be deleted, at D1000
- ② Set up PT DEL TRIGGER('5') at D1003
- ③ Wait until it's DONE ('1) after reading the data of D1004

▶ Insert of Segment

- ① Set up the No. of program pattern at D1000
- ② Set up the No. of segment , which will be inserted, at D1002
- ③ Set up the temperature, DAMP, TSP and segment time recorded at D1010~D1012
- ④ Set up the SEG INSERT TRIGGER('6') at D1003
- ⑤ Wait until it's DONE ('1) after reading the data of D1004

▶ Delete of Segment

- ① Set up the No. of program pattern at D1000
- ② Set up the No. of segment , which will be deleted, at D1002
- ③ Set up the SEG DEL TRIGGER('7') at D1003
- ④ Wait until it's DONE ('1) after reading the data of D1004

D-Register 0000 ~ 0599

NO	PROCESS	FUNCTION	RESERVATION	IS	ALARM / TS	HEAT_PID
	0	100	200	300	400	500
0		SET_PTNO	RESERVE			HEAT_PB1
1	TEMP_NPV	STATUS_MODE	NOW_YEAR			HEAT_TI1
2	TEMP_NSP	FIX_TEMP_SP	NOW_MONTH	IS1_TYPE		HEAT_TD1
3	DAMP_NSP	FIX_DAMP_SP	NOW_DAY	IS1_HIGH		HEAT_OH1
4		OP_MODE	NOW_HOUR	IS1_LOW		HEAT_OL1
5		PWR_MODE	NOW_MIN	IS1_DELAY_TM	AL1_MODE	HEAT_DB1
6	MVOUT	TEMP_SLOPE	RUN_YEAR	IS1_BAND	AL2_MODE	HEAT_MR1
7	HOUT	DAMP_SLOPE	RUN_MONTH		AL3_MODE	HEAT_PB2
8	COUT	FUZZY	RUN_DAY	IS2_TYPE	AL4_MODE	HEAT_TI2
9	C_PIDNO	TIME UNIT	RUN_HOUR	IS2_HIGH		HEAT_TD2
10	NOW_STS	FIX_OPTM_SELL	RUN_MIN	IS2_LOW	A1_POINT	HEAT_OH2
11	OTHER_STS	FIX_OPTM_H	SET_YEAR	IS2_DELAY_TM	A2_POINT	HEAT_OL2
12	IS_STS	FIX_OPTM_M	SET_MONTH	IS2_BAND	A3_POINT	HEAT_DB2
13	TS_STS		SET_DAY		A4_POINT	HEAT_MR2
14	AL_STS		SET_HOUR	IS3_TYPE		HEAT_PB3
15	SYS_ERR_STS		SET_MIN	IS3_HIGH	A1_HYS	HEAT_TI3
16	UO_STSSL	TEMP_RP1		IS3_LOW	A2_HYS	HEAT_TD3
17	UO_STSSH	TEMP_RP2		IS3_DELAY_TM	A3_HYS	HEAT_OH3
18	DI_DATA	RDV		IS3_BAND	A4_HYS	HEAT_OL3
19	ADERR_STS	RHY				HEAT_DB3
20	PROC_TIME_H	WAITMD		IS4_TYPE	TS02_ONTM	HEAT_MR3
21	PROC_TIME_M	TEMP_WAIT_ZONE		IS4_HIGH	TS02_OFFTM	HEAT_PB4
22		WAIT_TIME		IS4_LOW	TS03_ONTM	HEAT_TI4
23				IS4_DELAY_TM	TS03_OFFTM	HEAT_TD4
24				IS4_BAND	TS04_ONTM	HEAT_OH4
25	RUN_PTNO	BLGT_TM			TS04_OFFTM	HEAT_OL4
26	RUN_SEGNO	BUZZER_TM		IS5_TYPE	TS05_ONTM	HEAT_DB4
27	REMAIN_TIME_H			IS5_HIGH	TS05_OFFTM	HEAT_MR4
28	REMAIN_TIME_M	DAMP_HIDDEN		IS5_LOW	TS06_ONTM	
29	WAIT_TIME_H			IS5_DELAY_TM	TS06_OFFTM	CONTROL_MODE
30	WAIT_TIME_M			IS5_BAND	TS07_ONTM	
31	NOW_PT_RPT				TS07_OFFTM	
32	TOTAL_PT_RPT			IS6_TYPE		
33	NOW_SEG_RPT			IS6_HIGH	DI_SELECT	
34	TOTAL_SEG_RPT			IS6_LOW		
35	PREV_TEMP_TSP			IS6_DELAY_TM		

NO	PROCESS	FUNCTION	RESERVATION	IS	ALARM / TS	HEAT_PID
	0	100	200	300	400	500
36	NOW_TEMP_TSP			IS6_BAND		
37	PREV_DAMP_TSP					
38	NOW_DAMP_TSP			IS7_TYPE		
39	NOW_SEG_TIME			IS7_HIGH		
40				IS7_LOW		
41				IS7_DELAY_TM		
42				IS7_BAND		
43						
44				IS8_TYPE		
45				IS8_HIGH		
46				IS8_LOW		
47				IS8_DELAY_TM		
48				IS8_BAND		
49						
50						
51						
52						
53						
54						
55						
56						
57						
58						
59						
60						
61						
62						
63						
64						
65						
66						
67						
68						
69						
70						
71						

NO	PROCESS	FUNCTION	RESERVATION	IS	ALARM / TS	HEAT_PID
	0	100	200	300	400	500
72						
73						
74						
75						
76						
77						
78						
79						
80						
81						
82						
83						
84						
85						
86						
87						
88						
89						
90						
91						
92						
93						
94						
95						
96						
97						
98						
99						

D-Register 0600 ~ 1199

NO	COOL_PID	COMM	OUTPUT	INPUT	PROGRAM	RESERVED
	600	700	800	900	1000	1100
0	COOL_PB1	PROTOCOL	HEAT_OT	IN_GROUP	P_PTNO	
1	COOL_TI1	BAUD_RATE	HEAT_CT	SENSOR_TYPE	DEST_PTNO	
2	COOL_TD1	PARITY	HEAT_ATGAIN	SENSOR_UNIT	P_SEGNO	
3	COOL_OH1	STOP_BIT	HEAT_PO	TEMP_RH	TRIGGER	
4	COOL_OL1	DATA_LENGTH		TEMP_RL	ANSWER	
5		ADDRESS	COOL_OT	DOT_POS	PTN_NAME1	
6		RESPONSE	COOL_CT	ALL_BIAS	PTN_NAME2	
7	COOL_PB2		COOL_ATGAIN	FILTER	PTN_NAME3	
8	COOL_TI2		COOL_PO	TEMP_SH	PTN_NAME4	
9	COOL_TD2			TEMP_SL		
10	COOL_OH2		DIRECTION		TEMP_TSP	
11	COOL_OL2		ARW	TC_SELECT	DAMP_TSP	
12					SEG_TIME	
13					TS1	
14	COOL_PB3				TS2	
15	COOL_TI3		RET_SELECT		TS3	
16	COOL_TD3		RET_SH		TS4	
17	COOL_OH3		RET_SL			
18	COOL_OL3					
19						
20						
21	COOL_PB4				START_CODE	
22	COOL_TI4				SSP_VALUE	
23	COOL_TD4					
24	COOL_OH4					
25	COOL_OL4					
26						
27						
28						
29						
30						
31						
32						
33						
34						
35						

NO	COOL_PID	COMM	OUTPUT	INPUT	PROGRAM	RESERVED
	600	700	800	900	1000	1100
36						
37						
38						
39						
40			DO_IS1			
41			DO_IS2			
42			DO_IS3			
43			DO_IS4			
44			DO_IS5			
45			DO_IS6			
46			DO_IS7			
47			DO_IS8			
48						
49						
50			DO_TS1			
51			DO_TS2			
52			DO_TS3			
53			DO_TS4			
54						
55			DO_AL1			
56			DO_AL2			
57			DO_AL3			
58			DO_AL4			
59						
60						
61						
62						
63						
64						
65						
66						
67						
68						
69						
70			DO_RUN			
71			DO_RUNPARA			

NO	COOL_PID	COMM	OUTPUT	INPUT	PROGRAM	RESERVED
	600	700	800	900	1000	1100
72			DO_UP			
73			DO_UPPARA			
74			DO_SK			
75			DO_SKPARA			
76			DO_DN			
77			DO_DNPARA			
78			DO_ERROR			
79			DO_ERRORPARA			
80			DO_PTEND			
81			DO_PTENDPARA			
82			DO_1REF			
83			DO_1REFPARA			
84			DO_2REF			
85			DO_REFPARA			
86						
87						
88						
89						
90						
91						
92						
93						
94						
95						
96						
97						
98						
99						

D-Register 1200~1799

NO	RESERVED	FILE1	FILE2	FILE3	PROG_INFO	FILE4
	1200	1300	1400	1500	1600	1700
0						
1		C_TSP1	C_DSP1	C_TM1		C_TS11
2		C_TSP2	C_DSP2	C_TM2		C_TS12
3		C_TSP3	C_DSP3	C_TM3	PT_REPEAT	C_TS13
4		C_TSP4	C_DSP4	C_TM4	RPT_SEG_S1	C_TS14
5		C_TSP5	C_DSP5	C_TM5	RPT_SEG_E1	C_TS15
6		C_TSP6	C_DSP6	C_TM6	RPT_SEG_C1	C_TS16
7		C_TSP7	C_DSP7	C_TM7	RPT_SEG_S2	C_TS17
8		C_TSP8	C_DSP8	C_TM8	RPT_SEG_E2	C_TS18
9		C_TSP9	C_DSP9	C_TM9	RPT_SEG_C2	C_TS19
10		C_TSP10	C_DSP10	C_TM10	RPT_SEG_S3	C_TS110
11		C_TSP11	C_DSP11	C_TM11	RPT_SEG_E3	C_TS111
12		C_TSP12	C_DSP12	C_TM12	RPT_SEG_C3	C_TS112
13		C_TSP13	C_DSP13	C_TM13	RPT_SEG_S4	C_TS113
14		C_TSP14	C_DSP14	C_TM14	RPT_SEG_E4	C_TS114
15		C_TSP15	C_DSP15	C_TM15	RPT_SEG_C4	C_TS115
16		C_TSP16	C_DSP16	C_TM16		C_TS116
17		C_TSP17	C_DSP17	C_TM17		C_TS117
18		C_TSP18	C_DSP18	C_TM18	LINK_PT	C_TS118
19		C_TSP19	C_DSP19	C_TM19	PT E.MODE	C_TS119
20		C_TSP20	C_DSP20	C_TM20		C_TS120
21		C_TSP21	C_DSP21	C_TM21		C_TS121
22		C_TSP22	C_DSP22	C_TM22		C_TS122
23		C_TSP23	C_DSP23	C_TM23		C_TS123
24		C_TSP24	C_DSP24	C_TM24		C_TS124
25		C_TSP25	C_DSP25	C_TM25		C_TS125
26		C_TSP26	C_DSP26	C_TM26		C_TS126
27		C_TSP27	C_DSP27	C_TM27		C_TS127
28		C_TSP28	C_DSP28	C_TM28		C_TS128
29		C_TSP29	C_DSP29	C_TM29		C_TS129
30		C_TSP30	C_DSP30	C_TM30		C_TS130
31		C_TSP31	C_DSP31	C_TM31		C_TS131
32		C_TSP32	C_DSP32	C_TM32		C_TS132
33		C_TSP33	C_DSP33	C_TM33		C_TS133
34		C_TSP34	C_DSP34	C_TM34		C_TS134
35		C_TSP35	C_DSP35	C_TM35		C_TS135

NO	RESERVED	FILE1	FILE2	FILE3	PROG_INFO	FILE4
	1200	1300	1400	1500	1600	1700
36		C_TSP36	C_DSP36	C_TM36		C_TS136
37		C_TSP37	C_DSP37	C_TM37		C_TS137
38		C_TSP38	C_DSP38	C_TM38		C_TS138
39		C_TSP339	C_DSP39	C_TM39		C_TS139
40		C_TSP40	C_DSP40	C_TM40		C_TS140
41		C_TSP41	C_DSP41	C_TM41		C_TS141
42		C_TSP42	C_DSP42	C_TM42		C_TS142
43		C_TSP43	C_DSP43	C_TM43		C_TS143
44		C_TSP44	C_DSP44	C_TM44		C_TS144
45		C_TSP45	C_DSP45	C_TM45		C_TS145
46		C_TSP46	C_DSP46	C_TM46		C_TS146
47		C_TSP47	C_DSP47	C_TM47		C_TS147
48		C_TSP48	C_DSP48	C_TM48		C_TS148
49		C_TSP49	C_DSP49	C_TM49		C_TS149
50		C_TSP50	C_DSP50	C_TM50		C_TS150
51		C_TSP51	C_DSP51	C_TM51		C_TS151
52		C_TSP52	C_DSP52	C_TM52		C_TS152
53		C_TSP53	C_DSP53	C_TM53		C_TS153
54		C_TSP54	C_DSP54	C_TM54		C_TS154
55		C_TSP55	C_DSP55	C_TM55		C_TS155
56		C_TSP56	C_DSP56	C_TM56		C_TS156
57		C_TSP57	C_DSP57	C_TM57		C_TS157
58		C_TSP58	C_DSP58	C_TM58		C_TS158
59		C_TSP59	C_DSP59	C_TM59		C_TS159
60		C_TSP60	C_DSP60	C_TM60		C_TS160
61		C_TSP61	C_DSP61	C_TM61		C_TS161
62		C_TSP62	C_DSP62	C_TM62		C_TS162
63		C_TSP63	C_DSP63	C_TM63		C_TS163
64		C_TSP64	C_DSP64	C_TM64		C_TS164
65		C_TSP65	C_DSP65	C_TM65		C_TS165
66		C_TSP66	C_DSP66	C_TM66		C_TS166
67		C_TSP67	C_DSP67	C_TM67		C_TS167
68		C_TSP68	C_DSP68	C_TM68		C_TS168
69		C_TSP69	C_DSP69	C_TM69		C_TS169
70		C_TSP70	C_DSP70	C_TM70		C_TS170
71		C_TSP71	C_DSP71	C_TM71		C_TS171

NO	RESERVED	FILE1	FILE2	FILE3	PROG_INFO	FILE4
	1200	1300	1400	1500	1600	1700
72		C_TSP72	C_DSP72	C_TM72		C_TS172
73		C_TSP73	C_DSP73	C_TM73		C_TS173
74		C_TSP74	C_DSP74	C_TM74		C_TS174
75		C_TSP75	C_DSP75	C_TM75		C_TS175
76		C_TSP76	C_DSP76	C_TM76		C_TS176
77		C_TSP77	C_DSP77	C_TM77		C_TS177
78		C_TSP78	C_DSP78	C_TM78		C_TS178
79		C_TSP79	C_DSP79	C_TM79		C_TS179
80		C_TSP80	C_DSP80	C_TM80		C_TS180
81		C_TSP81	C_DSP81	C_TM81		C_TS181
82		C_TSP82	C_DSP82	C_TM82		C_TS182
83		C_TSP83	C_DSP83	C_TM83		C_TS183
84		C_TSP84	C_DSP84	C_TM84		C_TS184
85		C_TSP85	C_DSP85	C_TM85		C_TS185
86		C_TSP86	C_DSP86	C_TM86		C_TS186
87		C_TSP87	C_DSP87	C_TM87		C_TS187
88		C_TSP88	C_DSP88	C_TM88		C_TS188
89		C_TSP89	C_DSP89	C_TM89		C_TS189
90		C_TSP90	C_DSP90	C_TM90		C_TS190
91		C_TSP91	C_DSP91	C_TM91		C_TS191
92		C_TSP92	C_DSP92	C_TM92		C_TS192
93		C_TSP93	C_DSP93	C_TM93		C_TS193
94		C_TSP94	C_DSP94	C_TM94		C_TS194
95		C_TSP95	C_DSP95	C_TM95		C_TS195
96		C_TSP96	C_DSP96	C_TM96		C_TS196
97		C_TSP97	C_DSP97	C_TM97		C_TS197
98		C_TSP98	C_DSP98	C_TM98		C_TS198
99		C_TSP99	C_DSP99	C_TM99		C_TS199

D-Register 1800~2399

NO	FILE5	FILE6	FILE7	RESERVED	RESERVED	RESERVED
	1800	1900	2000	2100	2200	2300
0						
1	C_TS21	C_TS31	C_TS41			
2	C_TS22	C_TS32	C_TS42			
3	C_TS23	C_TS33	C_TS43			
4	C_TS24	C_TS34	C_TS44			
5	C_TS25	C_TS35	C_TS45			
6	C_TS26	C_TS36	C_TS46			
7	C_TS27	C_TS37	C_TS47			
8	C_TS28	C_TS38	C_TS48			
9	C_TS29	C_TS39	C_TS49			
10	C_TS210	C_TS310	C_TS410			
11	C_TS211	C_TS311	C_TS411			
12	C_TS212	C_TS312	C_TS412			
13	C_TS213	C_TS313	C_TS413			
14	C_TS214	C_TS314	C_TS414			
15	C_TS215	C_TS315	C_TS415			
16	C_TS216	C_TS316	C_TS416			
17	C_TS217	C_TS317	C_TS417			
18	C_TS218	C_TS318	C_TS418			
19	C_TS219	C_TS319	C_TS419			
20	C_TS220	C_TS320	C_TS420			
21	C_TS221	C_TS321	C_TS421			
22	C_TS222	C_TS322	C_TS422			
23	C_TS223	C_TS323	C_TS423			
24	C_TS224	C_TS324	C_TS424			
25	C_TS225	C_TS325	C_TS425			
26	C_TS226	C_TS326	C_TS426			
27	C_TS227	C_TS327	C_TS427			
28	C_TS228	C_TS328	C_TS428			
29	C_TS229	C_TS329	C_TS429			
30	C_TS230	C_TS330	C_TS430			
31	C_TS231	C_TS331	C_TS431			
32	C_TS232	C_TS332	C_TS432			
33	C_TS233	C_TS333	C_TS433			
34	C_TS234	C_TS334	C_TS434			
35	C_TS235	C_TS335	C_TS435			

NO	FILE5	FILE6	FILE7	RESERVED	RESERVED	RESERVED
	1800	1900	2000	2100	2200	2300
36	C_TS236	C_TS336	C_TS436			
37	C_TS237	C_TS337	C_TS437			
38	C_TS238	C_TS338	C_TS438			
39	C_TS239	C_TS339	C_TS439			
40	C_TS240	C_TS340	C_TS440			
41	C_TS241	C_TS341	C_TS441			
42	C_TS242	C_TS342	C_TS442			
43	C_TS243	C_TS343	C_TS443			
44	C_TS244	C_TS344	C_TS444			
45	C_TS245	C_TS345	C_TS445			
46	C_TS246	C_TS346	C_TS446			
47	C_TS247	C_TS347	C_TS447			
48	C_TS248	C_TS348	C_TS448			
49	C_TS249	C_TS349	C_TS449			
50	C_TS250	C_TS350	C_TS450			
51	C_TS251	C_TS351	C_TS451			
52	C_TS252	C_TS352	C_TS452			
53	C_TS253	C_TS353	C_TS453			
54	C_TS254	C_TS354	C_TS454			
55	C_TS255	C_TS355	C_TS455			
56	C_TS256	C_TS356	C_TS456			
57	C_TS257	C_TS357	C_TS457			
58	C_TS258	C_TS358	C_TS458			
59	C_TS259	C_TS359	C_TS459			
60	C_TS260	C_TS360	C_TS460			
61	C_TS261	C_TS361	C_TS461			
62	C_TS262	C_TS362	C_TS462			
63	C_TS263	C_TS363	C_TS463			
64	C_TS264	C_TS364	C_TS464			
65	C_TS265	C_TS365	C_TS465			
66	C_TS266	C_TS366	C_TS466			
67	C_TS267	C_TS367	C_TS467			
68	C_TS268	C_TS368	C_TS468			
69	C_TS269	C_TS369	C_TS469			
70	C_TS270	C_TS370	C_TS470			
71	C_TS271	C_TS371	C_TS471			

NO	FILE5	FILE6	FILE7	RESERVED	RESERVED	RESERVED
	1800	1900	2000	2100	2200	2300
72	C_TS272	C_TS372	C_TS472			
73	C_TS273	C_TS373	C_TS473			
74	C_TS274	C_TS374	C_TS474			
75	C_TS275	C_TS375	C_TS475			
76	C_TS276	C_TS376	C_TS476			
77	C_TS277	C_TS377	C_TS477			
78	C_TS278	C_TS378	C_TS478			
79	C_TS279	C_TS379	C_TS479			
80	C_TS280	C_TS380	C_TS480			
81	C_TS281	C_TS381	C_TS481			
82	C_TS282	C_TS382	C_TS482			
83	C_TS283	C_TS383	C_TS483			
84	C_TS284	C_TS384	C_TS484			
85	C_TS285	C_TS385	C_TS485			
86	C_TS286	C_TS386	C_TS486			
87	C_TS287	C_TS387	C_TS487			
88	C_TS288	C_TS388	C_TS488			
89	C_TS289	C_TS389	C_TS489			
90	C_TS290	C_TS390	C_TS490			
91	C_TS291	C_TS391	C_TS491			
92	C_TS292	C_TS392	C_TS492			
93	C_TS293	C_TS393	C_TS493			
94	C_TS294	C_TS394	C_TS494			
95	C_TS295	C_TS395	C_TS495			
96	C_TS296	C_TS396	C_TS496			
97	C_TS297	C_TS397	C_TS497			
98	C_TS298	C_TS398	C_TS498			
99	C_TS299	C_TS399	C_TS499			



SAMWONTECH CO.,LTD.

202-703, Buchon Techno-park,
Yakdae-dong, Wonmi-gu, Buchon,
Gyeonggi-do, Korea 420-773

TEL : +82-32-326-9120,9121

FAX : +82-32-326-9119

<http://www.samwontech.com>

E-mail:webmaster@samwontech.com

Further information contact Samwontech